

Brac

by Nathalie Du Pasquier



MU
TIN
A

Brac

by Nathalie Du Pasquier

BRAC è un mattone disegnato dall'artista Nathalie Du Pasquier in esclusiva per Mutina. Si tratta di un elemento 3D da immaginare come versatile componente per la creazione di strutture e pareti di ogni tipo. BRAC è un elemento di design che è naturale evoluzione di BRIC, il progetto artistico sviluppato da Nathalie Du Pasquier specificatamente per lo spazio espositivo MUT - Mutina for Art. Affascinata dal mattone e dalle sue possibilità, l'artista lo ha elaborato come modulo da disporre verticalmente o orizzontalmente generando inaspettati giochi di luce e ombra all'interno di ogni ambiente.

La collezione BRAC ha 5 varianti di colore: argilla con superficie naturale matt, bianco, salvia, marrone e nero dalla finitura smaltata lucida.

Come in tutte le opere di Nathalie Du Pasquier, anche nella collezione BRAC emerge un senso di giocosa spiritualità, risultato della sua imprevedibile capacità di connettere emozionalmente luce, colore e suono all'interno dello spazio.

BRAC is a brick designed by artist Nathalie Du Pasquier exclusively for Mutina. It is a 3D element imagined as versatile component for the creation of all sorts of structures and walls. BRAC is a design element which is the natural evolution of BRIC, the artistic project specifically developed by Nathalie Du Pasquier for the MUT - Mutina For Art exhibition space. Fascinated by the brick and its possibilities, the artist has elaborated it as a module to be arranged vertically or horizontally, generating unexpected interplays of light and shadow within any environment.

The BRAC collection has a range of 5 colours: argilla, with a natural matt surface, bianco, salvia, marrone and nero with a bright glazed finish.

As in all Nathalie Du Pasquier's artworks, also in the BRAC collection a sense of playful spirituality emerges, outcome of her unpredictable ability to emotionally connect light, colour and sound within a space.



L'incontro con Mutina mi ha permesso dopo tanti anni, di pensare di nuovo a un progetto di design. Avevo dimenticato come può essere divertente. Mutina ha la dimensione che mi piace, parliamo tra di noi e decidiamo al momento, poi andiamo in trattoria.

After many years, the encounter with Mutina allowed me to work on a design project again. I had forgotten how funny that could be. Mutina has the size that I like, we talk to each other and decide in the moment, then we go in the trattoria.

Nathalie Du Pasquier

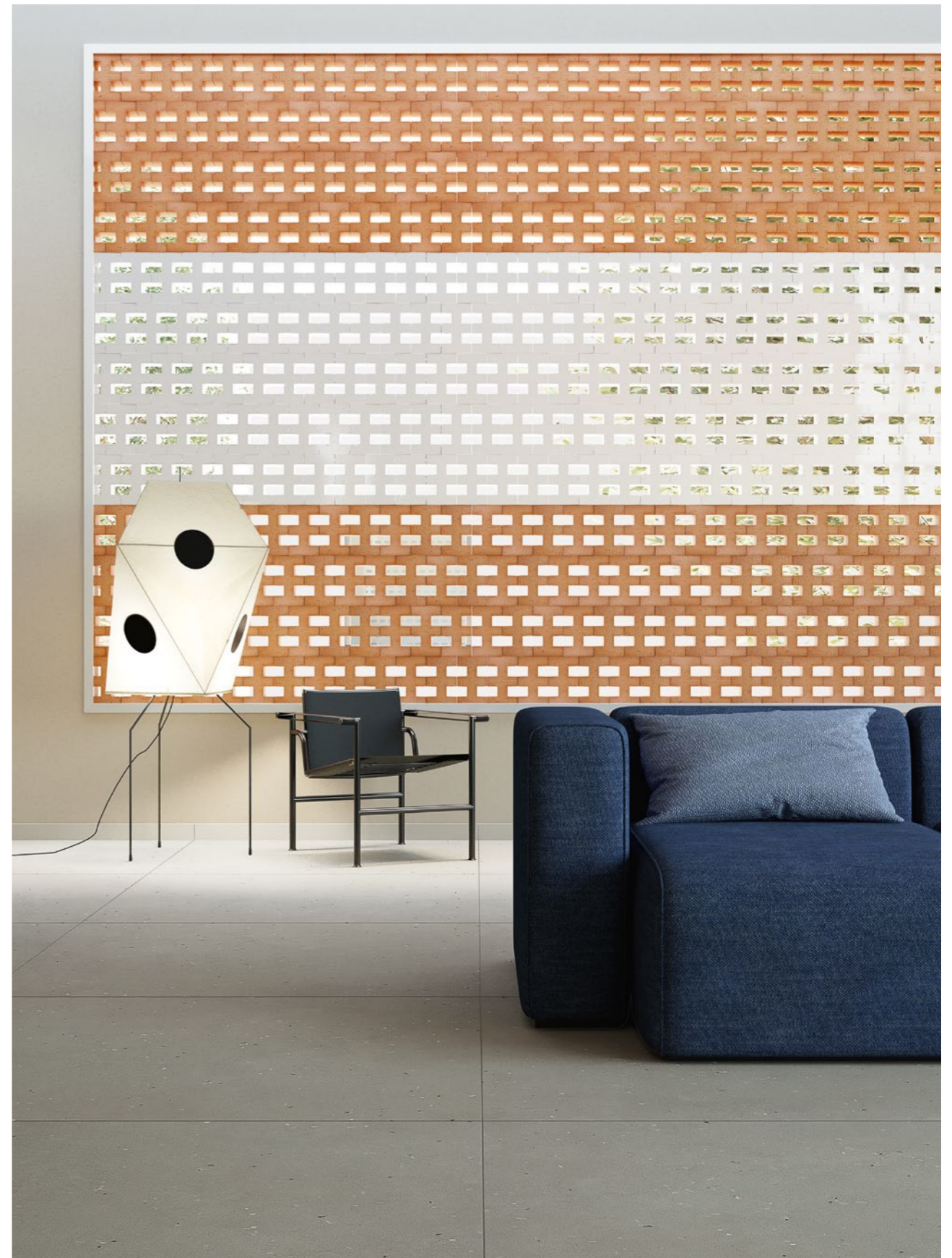

Wall: BRAC argilla, bianco

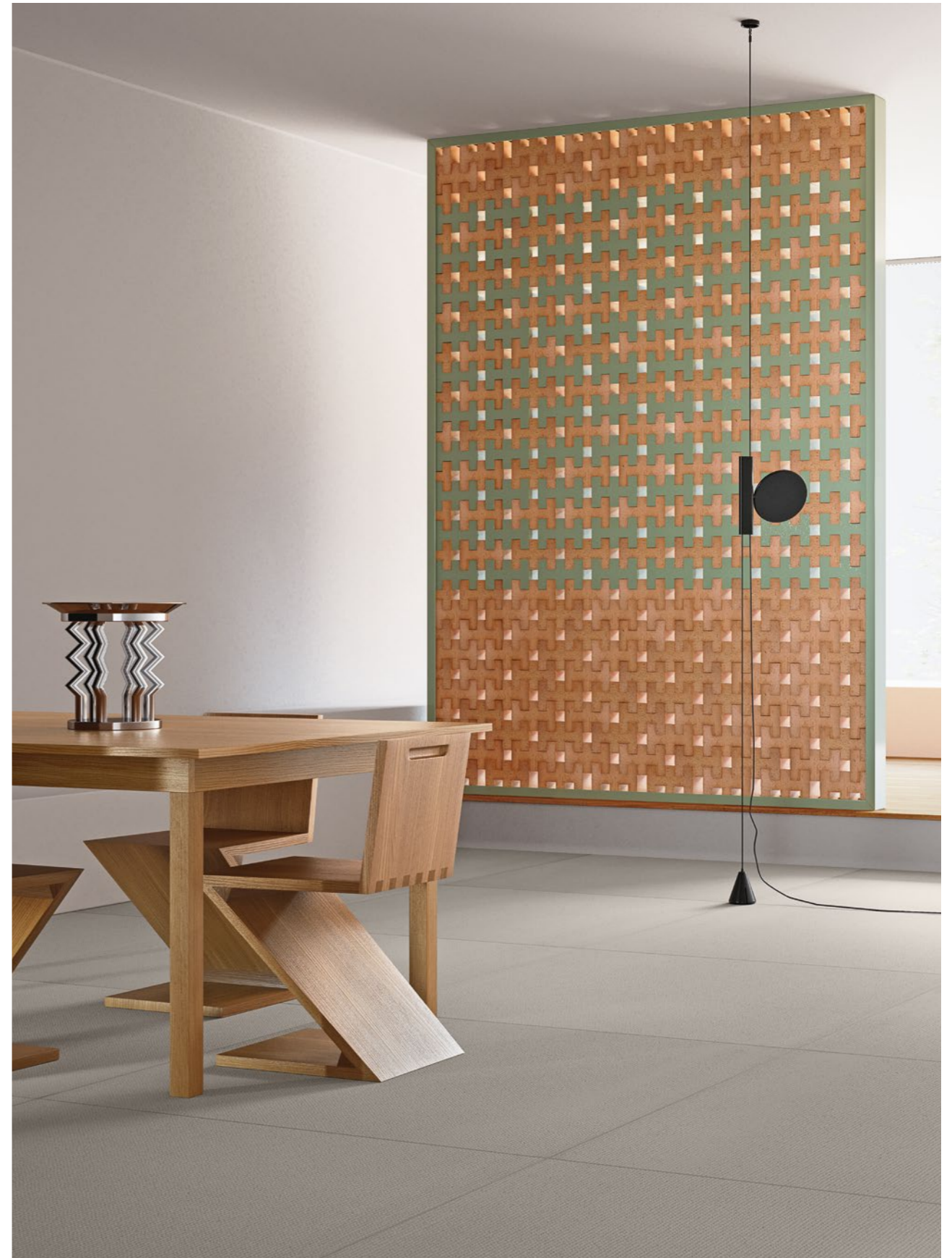

Wall: BRAC argilla, salvia

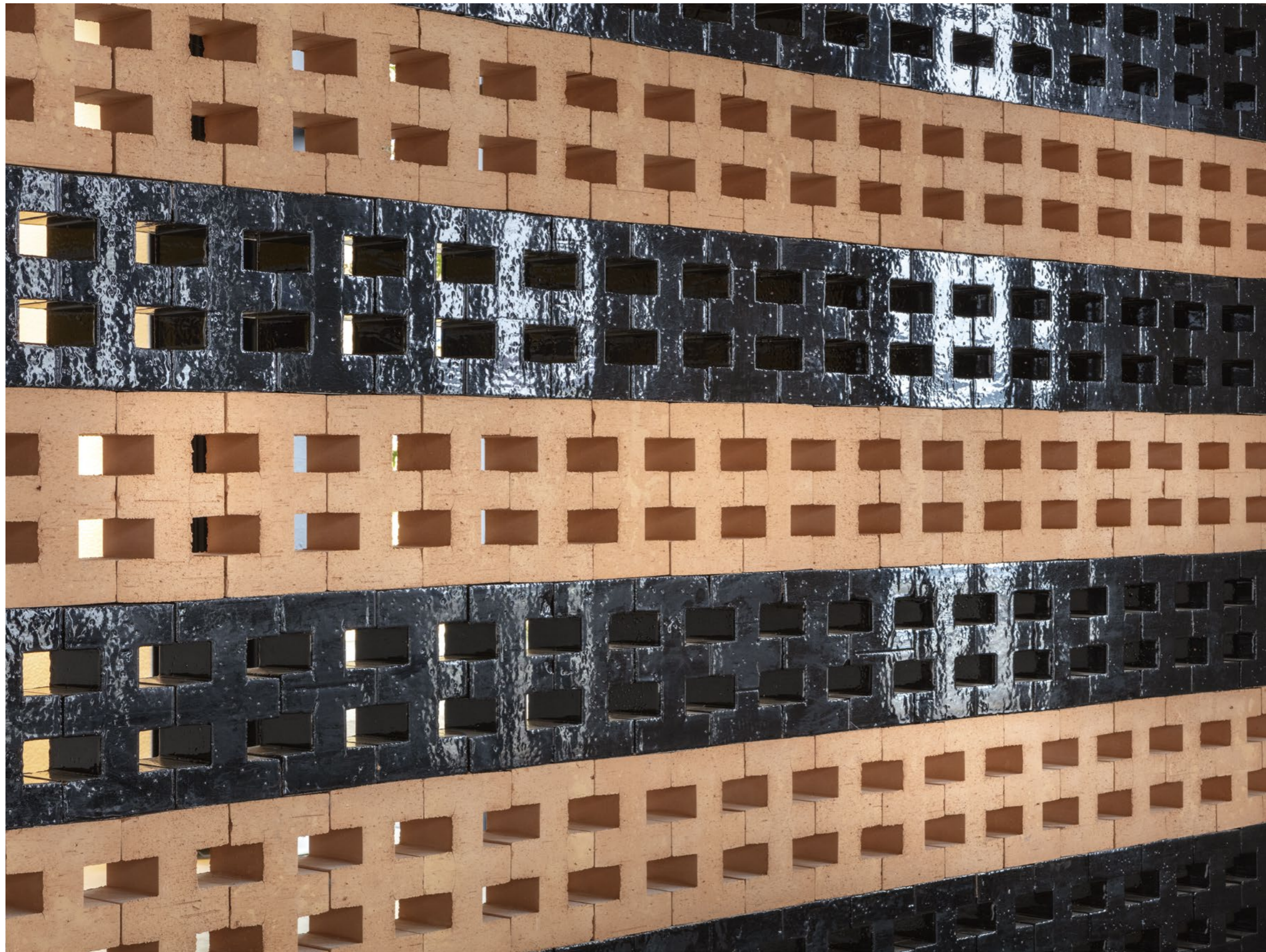

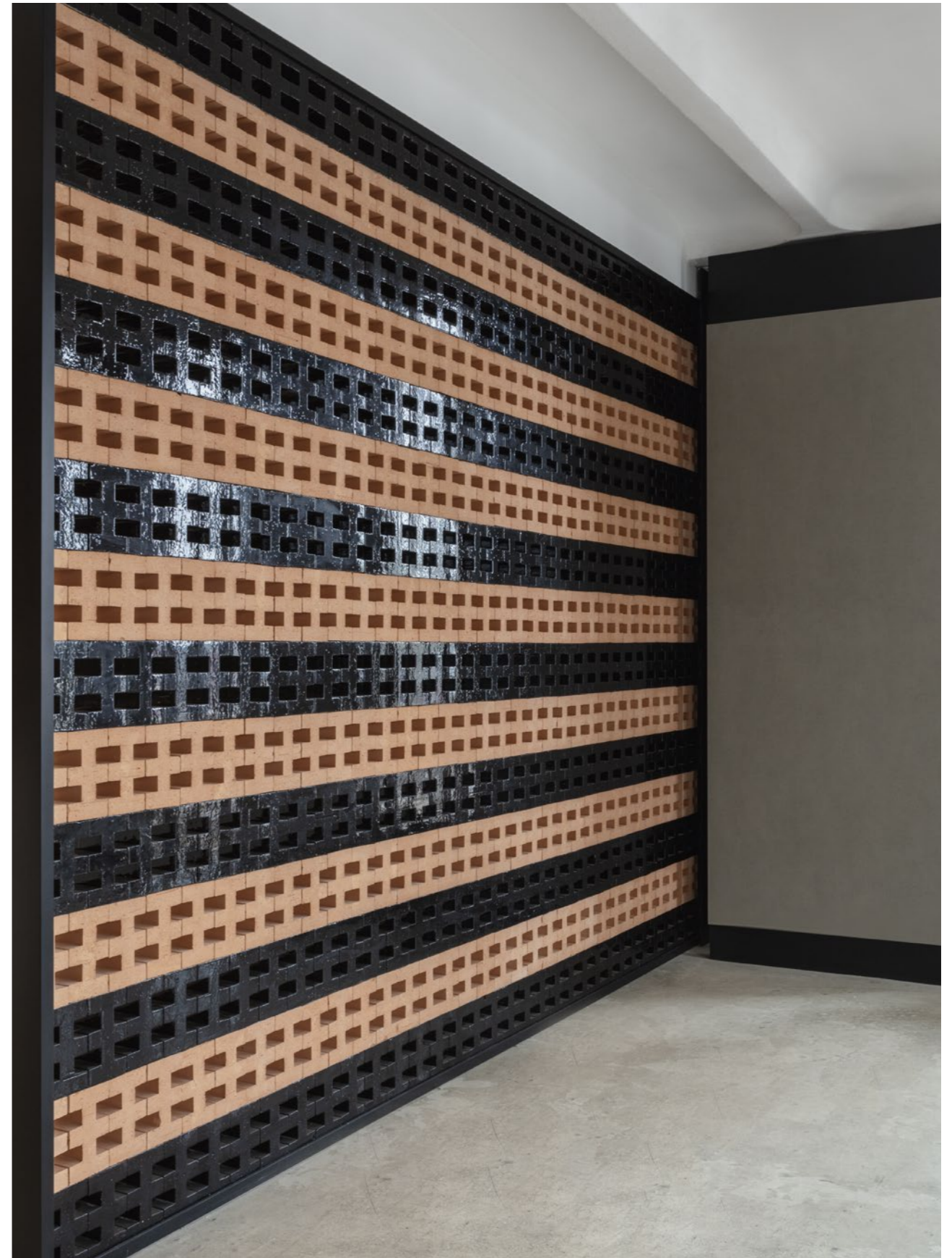

Wall: BRAC argilla, nero

Sizes & Colors

design	Nathalie Du Pasquier	2019
production	artisanal	
material	terracotta trafilata extruded terracotta	
*	misure nominali/nominal sizes	
size	* 13·22·10 cm/* 8"·5"·4"	

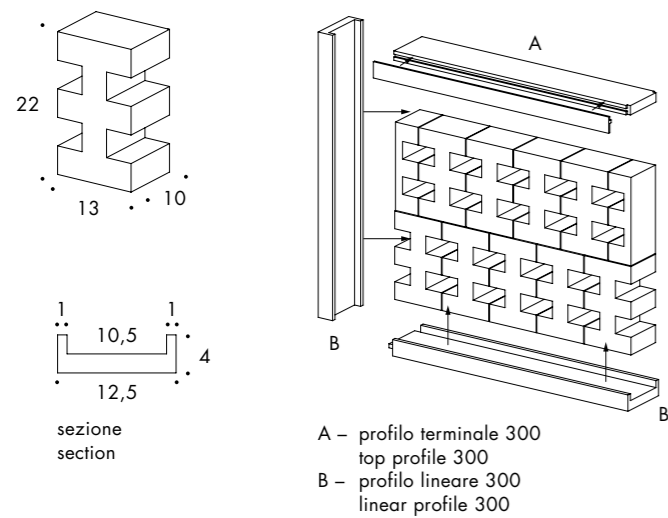

Per facilitare il montaggio di questi elementi è disponibile Mutina sigillante, un sigillante organico eco-compatibile acquistabile separatamente.

To make the installation of these items easier, a Mutina sealant is now available: an organic and eco-friendly sealing material, which is sold separately.

Laying Scheme

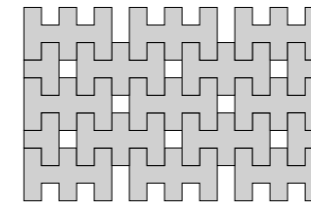

schema posa 1
laying scheme 1
42 pcs / sqm

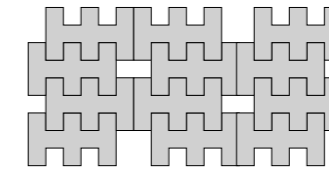

schema posa 2
laying scheme 2
42 pcs / sqm

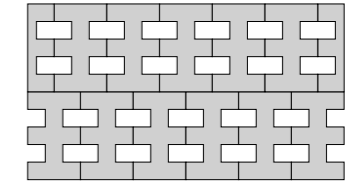

schema posa 3
laying scheme 3
35 pcs / sqm

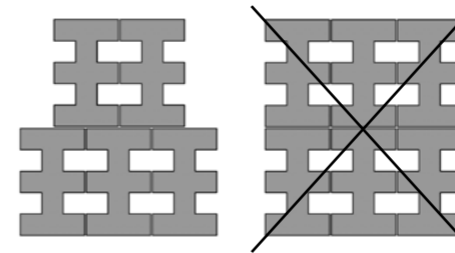

Per ragioni di sicurezza la posa è consentita tassativamente sempre e solo sfalsata.

For security reasons only staggered installation is strictly allowed.

Sizes & Colors



ARGILLA



BIANCO



NERO



SALVIA



MARRONE

Complementary Pieces

items	<p>Profilo lineare in salice verniciato (adatto per uso esterno). Linear painted willow profile (also suitable for outdoor use).</p> <p>Profilo terminale in legno di salice verniciato (adatto per uso esterno) con un'estremità sagomata ed un lato rimovibile per facilitare il montaggio della chiusura a soffitto. Top painted willow profile (also suitable for outdoor use) with one shaped end to make clamping easier.</p>
size	* 12,5·300·4 cm/* 4 ^{59/64} "·118 ^{7/64} "·1 ^{37/64} "
*	misure nominali/nominal sizes

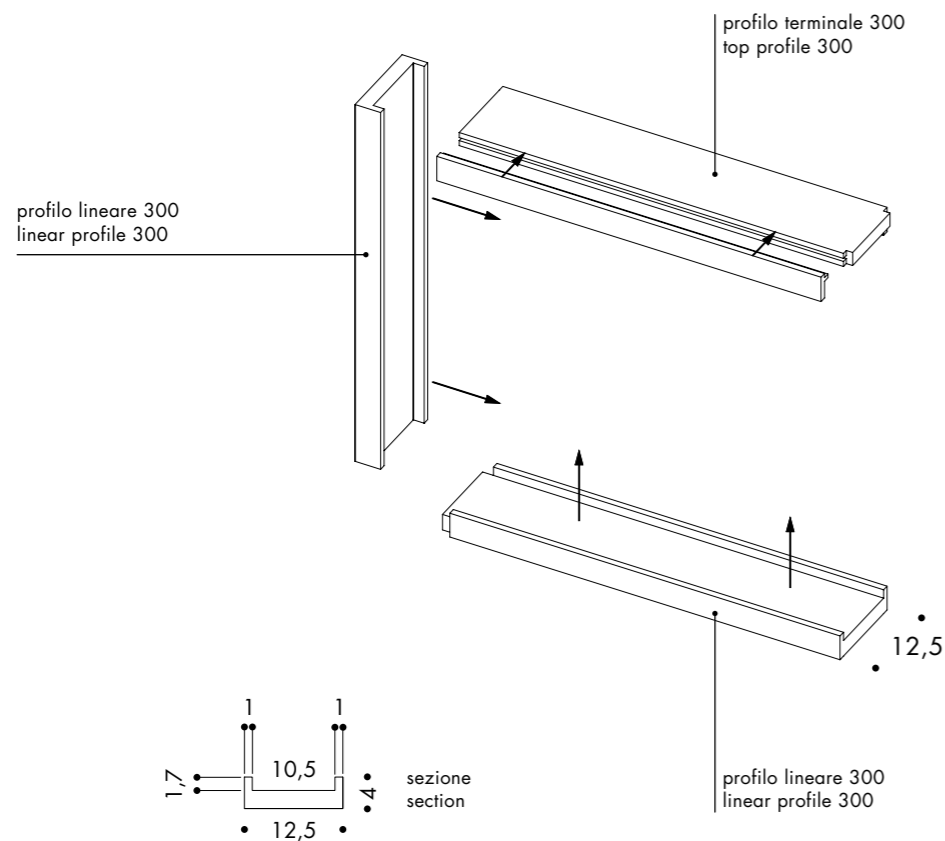

Complementary Pieces

	Mutina sigillante/Mutina sealant
material	<p>Sigillante organico eco-compatibile esente da solventi prodotto da Kerakoll in esclusiva per Mutina. Eco-friendly neutral silane sealant with reduced solvent content produced by Kerakoll exclusively for Mutina.</p>
features	<p>Mutina sigillante sviluppa un'elevata adesione su tutti i materiali senza l'utilizzo di primer e un'elasticità permanente su superfici assorbenti e inassorbenti. Mutina sealant develops a high level of adhesion on all materials without the use of primers and permanent elasticity on absorbent and non-absorbent surfaces.</p>
use	<p>In interno, esterno e per sigillature di elementi costruttivi. Suitable for indoor and outdoor use, it gives waterproof sealing of construction elements.</p>



Technical Features

Elementi di produzione artigianale trafilati di spessore 10cm. Gli elementi devono in ogni caso rispettare le norme tecniche in materia di costruzioni vigenti nel paese di utilizzo. Per il territorio nazionale italiano, in particolare, la norma NTC 2018 DECRETO MIN 27/01. Prodotto adatto sia per spazi residenziali che commerciali per la costruzione di pareti di altezza massima 4mt. Per ottenere un risultato estetico ottimale, si consiglia di montare BRAC utilizzando il profilo in legno. Per la chiusura a soffitto è previsto un profilo "terminale" con cornice smontabile. Prodotto adatto per interni ed esterni secondo norma UNI EN 722-22 con marcatura "F1 - esposizione moderata".

Artisanal extruded partition elements, 10cm thick. These elements must in any case comply with the technical standards of construction regulation, applicable in the country where they are installed. For the Italian national territory, in particular, they should comply with standard NTC 2018 DECRETO MIN 27/01.

This product is suitable for both residential and commercial areas, to be installed in walls with a maximum height of 4mt. In order to achieve an optimal aesthetic outcome we advise to install BRAC using our wooden profile. A top profile with removable sides is provided for ceiling fixing. The product is suitable for indoor and outdoor areas complying with UNI EN 722-22 marked "F1 - moderate exposure".

NORMA STANDARD	CARATTERISTICHE FEATURES	VALORE PRESCRITTO VALUE REQUIRED	BRAC
UNI EN 772-16	dimensioni dimensions	da dichiarare to declare	T2-R2
UNI EN 772-21	assorbimento water absorption	da dichiarare to declare	12,5%
UNI EN 772-5	tenore di sali solubili attivi soluble salts content	da dichiarare to declare	S2
UNI EN 772-22	resistenza al gelo freeze-thaw resistance	da dichiarare to declare	F1
D.M. 1401/2008	determinazione dei carichi variabili orizzontali determination of variable horizontal loads	da dichiarare to declare	C2
LEED CERTIFICATION 4.1			10%
VOC Emission			
Declaration of Contents			
SDS			
BPD3			
HPD			

Packing

FORMATO SIZE	PZ-MQ PCS-SQM	PZ-BOX PCS-BOX	MQ-PAL SQM-PAL	PZ-PAL PCS-PAL	KG-PZ KG-PC	KG-PAL KG-PAL
22-13-10 cm argilla	see page 15	–	1,35	48	3,70	177,60
22-13-10 cm bianco,nero,salvia,marrone	see page 15	3	4,06	48	3,70	532,80

Nathalie Du Pasquier



Nathalie Du Pasquier è nata a Bordeaux nel 1957 e vive a Milano dal 1979. Negli anni ottanta ha lavorato come designer, progettando soprattutto tessuti e superfici, ed è stata tra i fondatori del gruppo Memphis.

Dal 1987, si dedica prevalentemente alla pittura, un ambito in cui la sua pratica ha preso direzioni inaspettate ed è stata oggetto di una costante evoluzione. Il suo lavoro è stato esposto in mostre personali presso: Kunsthalle Wien, International Center of Graphic Arts di Ljubljana, Galerie Fuer Zeitgenoessische Kunst di Lipsia, Apalazzo Gallery di Brescia, Pace Gallery di Seoul e Anton Kern Gallery di New York.

Nathalie Du Pasquier was born in Bordeaux in 1957 and has lived in Milano since 1979. During the eighties, she has worked as a designer, creating textiles and mostly surfaces, and was a founding member of Memphis.

In 1987 painting became her main activity and ever since her practice is constantly developing in new and unexpected directions. Her work has been featured in solo exhibitions at Kunsthalle Wien, International Center of Graphic Arts in Ljubljana, Galerie Fuer Zeitgenoessische Kunst in Leipzig, Apalazzo Gallery in Brescia, Pace Gallery in Seoul and at Anton Kern Gallery in New York.

CREDITS

Art direction: Alla Carta Studio
Graphic design: Matteo Pastorio
Text: Mutina
Photography: Ilvio Gallo (p.4),
Cristiano Casolari (p.10,12)
Images: Germano Schillaci (p.7,9)
Illustration: Damien Florébert Cuypers
Catalogue update: October 2020

All the rights are reserved.
Not any part of this work can be reproduced
in any way without the preventive written
authorization by Mutina. All work is
copyrighted © to their respective owners.

To discover more about Mutina
collections visit mutina.it

Ceramiche Mutina Spa
Via Ghiarola Nuova 16
41042 Fiorano MO, Italia
T +39 0536812800
F +39 0536812808
info@mutina.it
www.mutina.it

© Mutina 2020

