

HEXAGON

LAB

APAVISA

HEXAGON LAB

APAVISA

INDEX

P. 02-03	Intro
P. 04-09	STARLINE:
p. 05	BLACK natural
p. 07	WHITE natural
p. 09	BLUE natural
P. 10-15	INTUITION:
p. 11	WHITE Circle and Wave
p. 13	BLACK Circle
p. 15	Patterns
P. 16-23	SOUTH:
p. 17	GREY natural
p. 19	GREEN natural
p. 21	WHITE natural
p. 23	PINK natural
P. 24-27	PUNTO CROCE:
p. 25	BLACK Decor
p. 27	WHITE natural
P. 28-33	ZINC:
p. 29	GREEN Mix Decor and GREEN natural
p. 31	SILVER Single
p. 33	SILVER Mix Decor
P. 34-37	NORTH DECOR:
p. 35	BLACK decor
p. 37	SAND decor
P. 38-41	NANOCONCEPT:
p. 39	WHITE Mix natural
p. 41	GREY Mix natural
P. 42-45	ALCHEMY:
p. 43	BLUE natural
p. 45	WHITE natural
P. 46-51	WIND:
p. 47	IVORY natural
p. 49	GREY natural
p. 51	MOSS natural
P. 56-59	Compilation
p. 60	Anti-Slip values. Packing.

HEXAGON

LAB

In the heart of APAVISA a new concept of creativity vibrates. The design is in each beat, marking a fascinating rhythm that will capture you from the first moment. New shapes, new colours and new concepts come together to give meaning to unexplored spaces and creating a trend. Welcome to this trip through our heart.



En el corazón de APAVISA vibra un nuevo concepto de creatividad. El diseño está en cada latido marcando un ritmo fascinante que te atraparà desde el primer momento. Nuevas formas, nuevos colores y nuevos conceptos se aunan para dar sentido a los espacios por explorar creando tendencia. Bienvenido a este viaje por nuestro corazón.

HEXAGON

LAB

STARLINE

COLLECTION



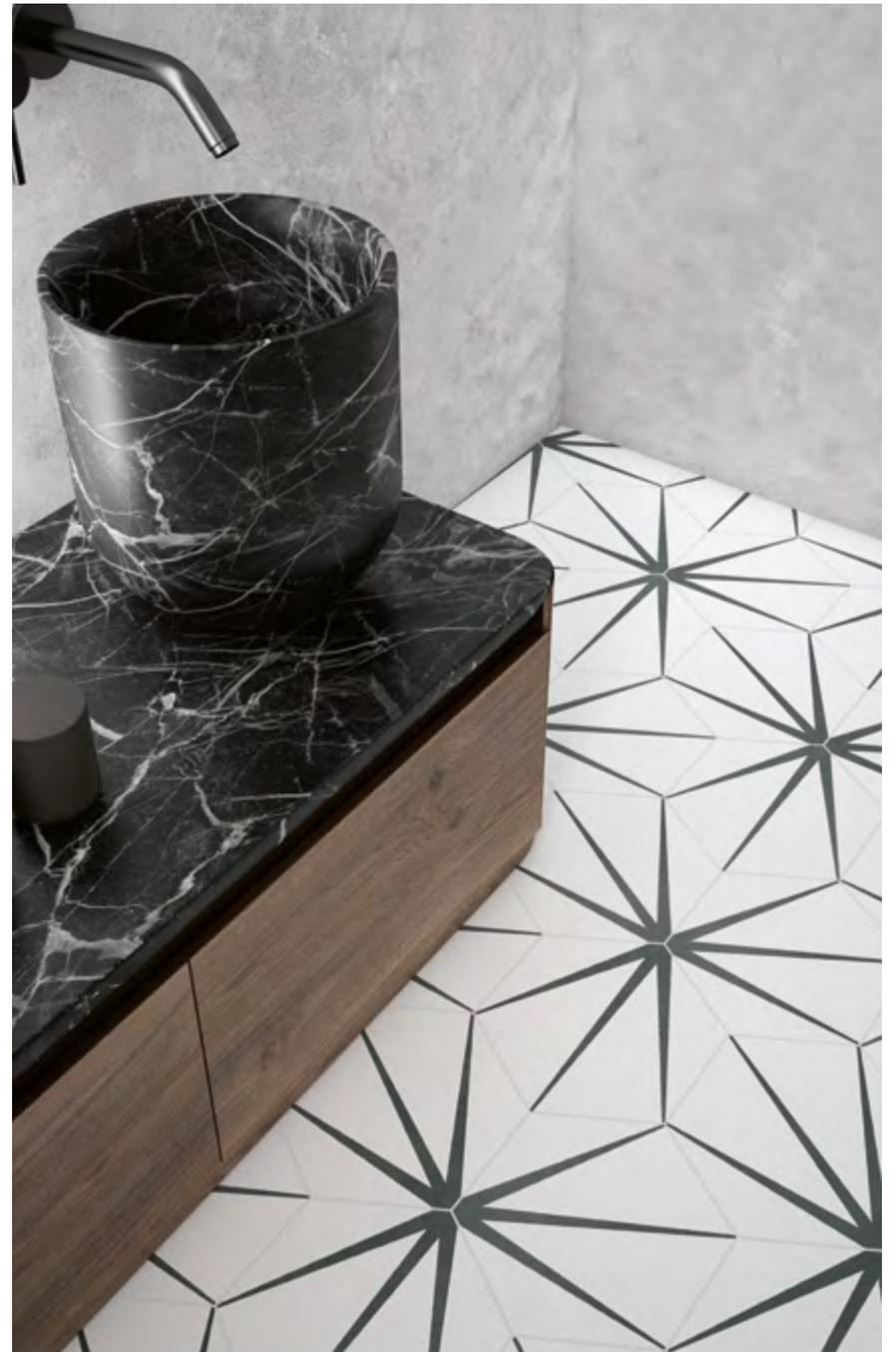

STARLINE

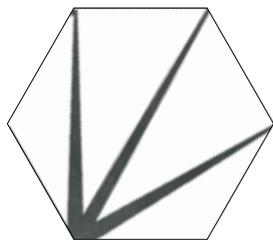

STARLINE WHITE
natural G-7230



STARLINE BLACK
natural G-7230



STARLINE BLUE
natural G-7230



ANTI-SLIP VALUES

Valores antideslizamiento



NON rectified material. Minimum installation joint when fixing is 2 mm.
Material NO rectificado. Junta mínima para su colocación de 2 mm.



INTUITION

COLLECTION





INTUITION

PATTERNS



INTUITION WHITE
natural G-7208



INTUITION WHITE
1 stamp
Circle G-7254



INTUITION WHITE
1 stamp
Wave G-7254



INTUITION BLACK
natural G-7208



INTUITION BLACK
1 stamp
Circle G-7254

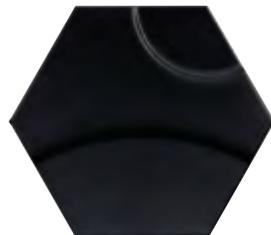

INTUITION BLACK
1 stamp
Wave G-7254



NON rectified material. Minimum installation joint when fixing is 2 mm.
Material NO rectificado. Junta mínima para su colocación de 2 mm.



Available in all colors.
Disponibles en todos los colores.

INTUITION Circle + INTUITION Wave.
1 Pieze 6 Piezes

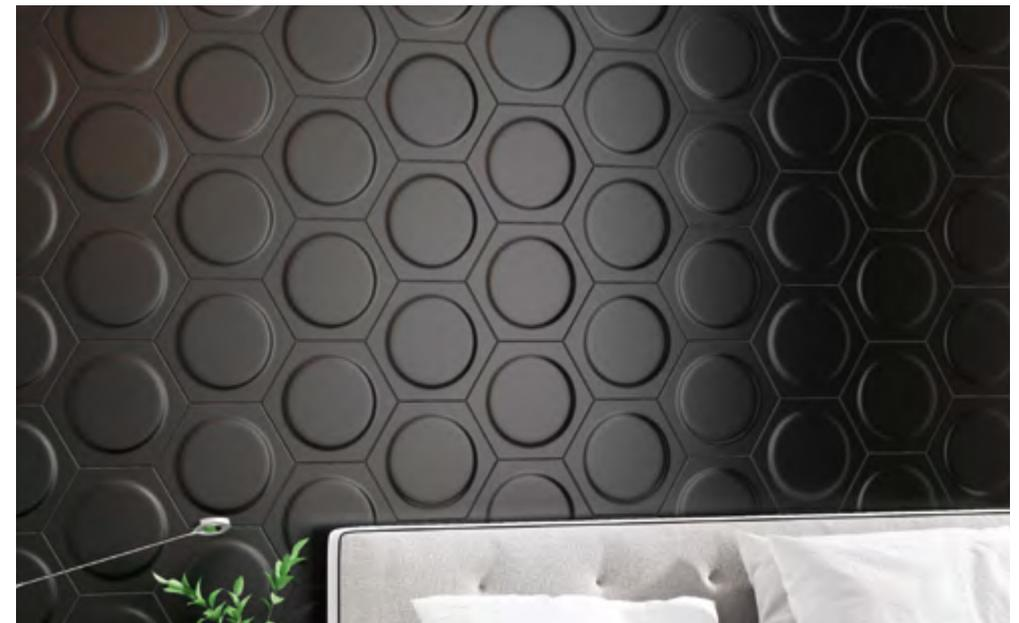

Available in all colors.
Disponibles en todos los colores.

INTUITION Circle
<15>

SOUTH

COLLECTION





◻ SOUTH GREEN natural





SOUTH

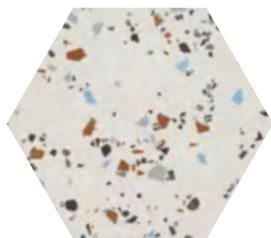

SOUTH WHITE
natural G-7230

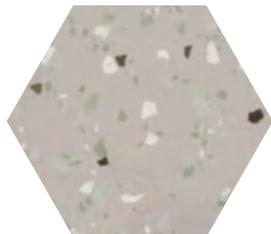

SOUTH GREY
natural G-7230

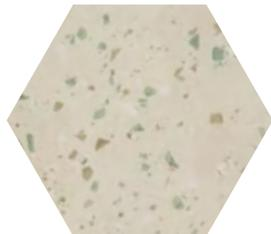

SOUTH GREEN
natural G-7230



SOUTH PINK
natural G-7230



size:
25x29
cm

colors:
04

finishes:
natural

ANTI-SLIP VALUES Valores antideslizamiento



DIN:
R10

DCOF:
>0,42

PTV:
>24

CLASE:
1

DIN 51130

ANSI A 137.1

BS-7976

UNE-ENV 12633

NON rectified material. Minimum installation joint when fixing is 2 mm.
Material NO rectificado. Junta mínima para su colocación de 2 mm.



PUNTO
CROCE
COLLECTION



PUNTO CROCE



PUNTO CROCE
BLACK decor G-7230



patterns:
21 mix



PUNTO CROCE
WHITE natural G-7230



patterns:
21 mix



ANTI-SLIP VALUES Valores antideslizamiento

size: 25x29 cm	colors: 02	patterns: 21 mix	finishes: natural decor	DIN: R10 DIN 51130	DCOF: >0,42 ANSI A 137.1	PTV: >24 BS-7976	CLASE: 1 UNE-ENV 12633
----------------------	---------------	---------------------	-------------------------------	---------------------------------	--	----------------------------------	-------------------------------------

NON rectified material. Minimum installation joint when fixing is 2 mm.
Material NO rectificado. Junta mínima para su colocación de 2 mm.



ZINC

COLLECTION





ZINC

SINGLE



ZINC SILVER
1 stamp
SINGLE G-7274

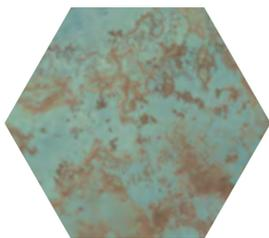

ZINC GREEN
natural G-7230

Natural finish ANTI-SLIP VALUES
Valores antideslizamiento acabado Natural

size:
25 x 29
cm

colors:
02

stamps:
01

finishes:
natural
single

DIN:
R10

DIN 51130

DCOF:
>0,42

ANSI A 137.1

PTV:
>24

BS-7976

CLASE:
1

UNE-ENV 12633

MIX DECOR



ZINC SILVER
3 stamps
Mix decor G-7274



ZINC GREEN
3 stamps
Mix decor G-7254



size:
25 x 29
cm

colors:
02

stamps:
03

finishes:
Mix decor



ZINC SILVER Mix decor

NON rectified material. Minimum installation joint when fixing is 2 mm.
Material NO rectificado. Junta mínima para su colocación de 2 mm.

NORTH
DECOR
COLLECTION



NORTH DECOR

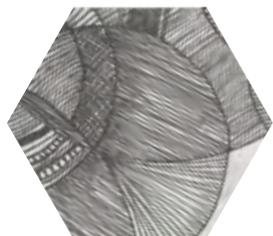

NORTH BLACK
decor G-7230

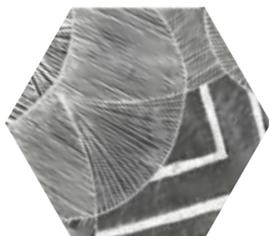

patterns:
32 mix

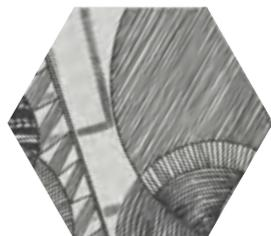

NORTH SAND
decor G-7230
Nonslip G-7254



patterns:
32 mix



ANTI-SLIP VALUES

Valores antideslizamiento

size: 25x29 cm	colors: 02	patterns: 32 mix	finishes: decor	DIN: R10 DIN 51130	DCOF: >0,42 ANSI A 137.1	PTV: >24 BS-7976	CLASE: 1 UNE-ENV 12633
			SAND Nonslip	DIN: R10 DIN 51130	DCOF: >0,42 ANSI A 137.1	PTV: >36 low slip BS-7976	CLASE: 1 UNE-ENV 12633

NON rectified material. Minimum installation joint when fixing is 2 mm.
Material NO rectificado. Junta mínima para su colocación de 2 mm.



 NORTH SAND Decor

NANOCONCEPT

COLLECTION



NANOCONCEPT



NANOCONCEPT
GREY Mix G-7230
Nonslip G-7254



patterns:
3 decors mix



NANOCONCEPT
WHITE Mix G-7230
Nonslip G-7254



patterns:
3 decors mix



ANTI-SLIP VALUES

Valores antideslizamiento

size: 25x29 cm	colors: 0 2	patterns: 3 mix	finishes: natural	DIN: R10 DIN 51130	DCOF: >0,42 ANSI A 137.1	PTV: >24 BS-7976	CLASE: 1 UNE-ENV 12633
Nonslip				DIN: R10 DIN 51130	DCOF: >0,42 ANSI A 137.1	PTV: >24 BS-7976	CLASE: 1 UNE-ENV 12633

NON rectified material. Minimum installation joint when fixing is 2 mm.
Material NO rectificado. Junta mínima para su colocación de 2 mm.



ALCHEMY

COLLECTION



ALCHEMY

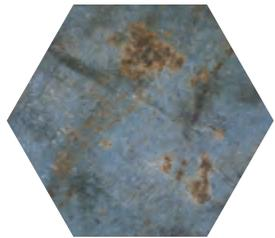

ALCHEMY BLUE
natural G-7230

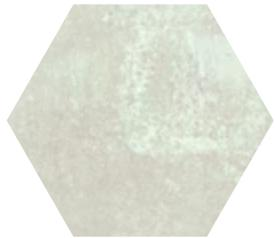
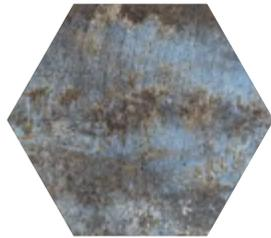
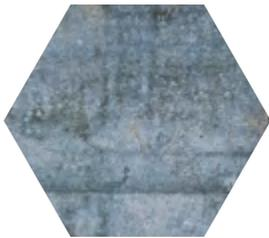

ALCHEMY WHITE
natural G-7230

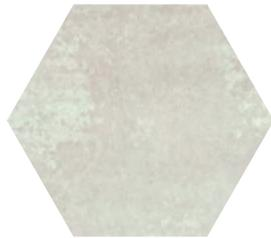

ANTI-SLIP VALUES Valores antideslizamiento

DIN: R10	DCOF: >0,42	PTV: >24	CLASE: 1
DIN 51130	ANSI A 137.1	BS-7976	UNE-ENV 12633

size: 25x29 cm	colors: 0 2	finishes: natural
----------------------	----------------	----------------------

NON rectified material. Minimum installation joint when fixing is 2 mm.
Material NO rectificado. Junta mínima para su colocación de 2 mm.



WIND

COLLECTION









WIND

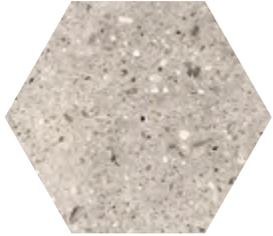

WIND IVORY
natural G-7230
Nonslip G-7254



WIND GREY
natural G-7230
Nonslip G-7254

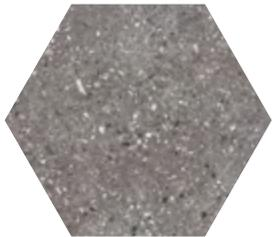

WIND MOSS
natural G-7230

size:
25x29
cm

colors:
0 3

patterns:
3 mix

finishes:
natural

DIN:
R10

DIN 51130

DCOF:
>0,42

ANSI A 137.1

PTV:
>24

BS-7976

CLASE:
1

UNE-ENV 12633

Nonslip

DIN:
R10

DIN 51130

DCOF:
>0,42

ANSI A 137.1

PTV:
>24

BS-7976

CLASE:
1

UNE-ENV 12633

ANTI-SLIP VALUES

Valores antideslizamiento



WIND MOSS natural

NON rectified material. Minimum installation joint when fixing is 2 mm.
Material NO rectificado. Junta mínima para su colocación de 2 mm.

STARLINE Pg.04-09



STARLINE BLUE
natural G-7230

STARLINE BLACK
natural G-7230

STARLINE WHITE
natural G-7230

PUNTO CROCE Pg.24-27



PUNTO CROCE
BLACK
decor G-7230

patterns:
21 mix

PUNTO CROCE
WHITE
natural G-7230

patterns:
21 mix

INTUITION Pg.10-15



INTUITION WHITE
Natural G-7208

INTUITION WHITE
1 stamp
Circle G-7254

INTUITION WHITE
1 stamp
Wave G-7254

ZINC MIX DECOR Pg.28-33



ZINC SILVER
3 stamps
Mix decor G-7274

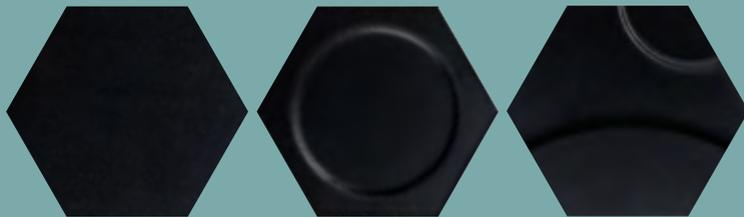

INTUITION BLACK
Natural G-7208

INTUITION BLACK
1 stamp
Circle G-7254

INTUITION BLACK
1 stamp
Wave G-7254

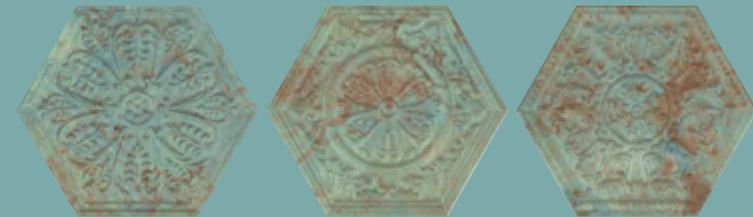

ZINC GREEN
3 stamps
Mix decor G-7254

SOUTH Pg.16-23

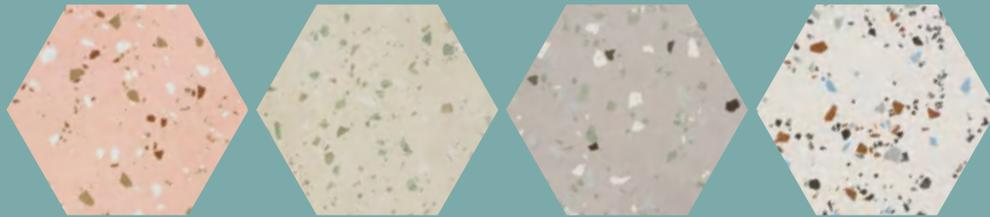

SOUTH PINK
natural G-7230

SOUTH GREEN
natural G-7230

SOUTH GREY
natural G-7230

SOUTH WHITE
natural G-7230

ZINC SINGLE Pg.28-31 ZINC NATURAL Pg.28

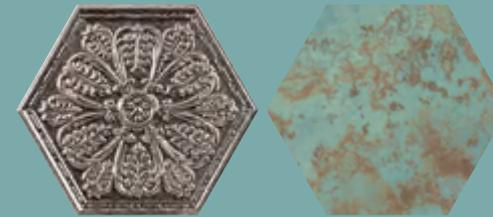

ZINC SILVER
1 stamp
SINGLE G-7274

ZINC GREEN
natural G-7230

NORTH Pg.34-37

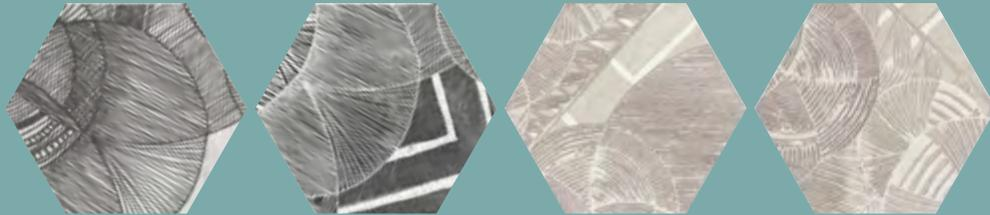

NORTH BLACK
decor G-7230

patterns:
32 mix

NORTH SAND
decor G-7230
Nonslip G-7254

patterns:
32 mix

WIND P.64-71



WIND IVORY
natural G-7230
Nonslip G-7254

WIND GREY
natural G-7230
Nonslip G-7254

WIND MOSS
natural G-7230

NANOCONCEPT P.38-41

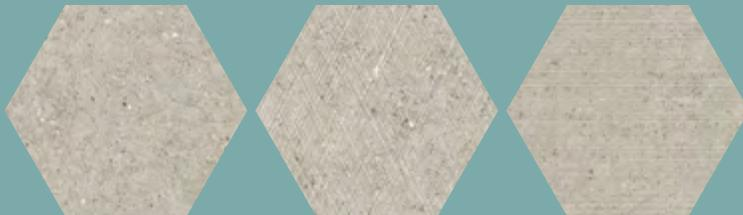

NANOCONCEPT
GREY Mix G-7230
Nonslip G-7254

patterns:
3 decors mix

NANOCONCEPT
WHITE Mix G-7230
Nonslip G-7254

patterns:
3 decors mix

ALCHEMY P.46-51

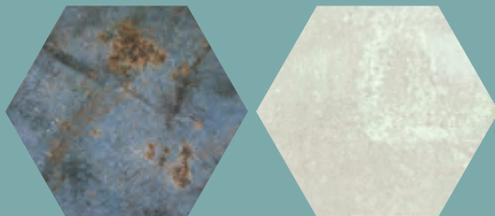

ALCHEMY BLUE
natural G-7230

ALCHEMY WHITE
natural G-7230

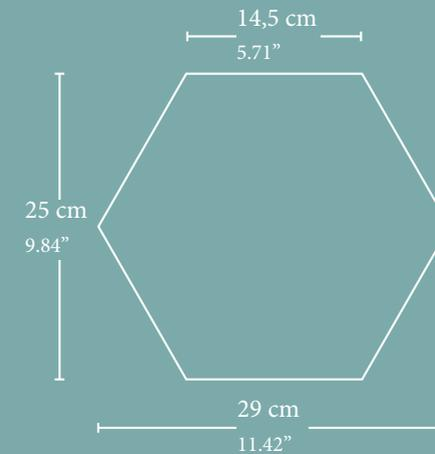

*NON rectified material. Minimum installation joint when fixing is 2 mm.
Material NO rectificado. Junta mínima para su colocación de 2 mm.*

Packing HEXAGON Lab

Name	Size cm	Size "	Box/Pallet	Pz/Box	M2/Box	SQF/Box	M2/Pallet	SQF/Pallet	Kg/Pallet	Kg/Box	Kg/Piece
Hexagon Lab	25 29	9,84 11,42	48	17	1,23	13,27	59,16	636,80	1068	21,767	1,271

The product may have variations in tone due to the manufacturing process. Ask about specific product before delivery. Photographs may present color variations with respect to the actual product. Ask about specific product before delivery.

El producto puede presentar variaciones de tono derivadas de proceso de fabricación. Realizar consulta de un producto específico antes del suministro.

Las fotografías editadas pueden presentar variaciones cromáticas respecto al producto real. Realizar consulta de un producto específico antes del suministro.



HEXAGON

LAB

APAVISIA PORCELANICO S.L. assumes no liability for any printing errors. The technical characteristics contained in this catalog are mean values of our products. To carry out any orders that are requested consultations with the technical characteristics of the particular model to APAVISIA PORCELANICO S.L.

All features and specifications are based on information available at the time of printing this catalog and may be changed without notice, according to market conditions, technological innovations and / or any other factor, without incurring any liability.

APAVISIA
www.apavisa.com

Ctra. Castellón – San Juan de Moró, hm.7,5
12130 SAN JUAN DE MORÓ (Castellón) Spain
Tel. +34 964 701 120 - Export Fax +34 964 701 067 - Fax Nacional 964 701 195
info@apavisa.com

APAVISIA PORCELANICO S.L. no asume ninguna responsabilidad por posibles errores de impresión. Las características técnicas que constan en el presente catálogo son valores medios de nuestros productos. Para la realización de cualquier pedido se solicita que sean consultadas las características técnicas del modelo en concreto a APAVISIA PORCELANICO S.L. Todas las características y especificaciones técnicas están basadas en la información disponible en el momento de la impresión del presente catálogo y podrán ser modificadas sin previo aviso, de acuerdo a las circunstancias del mercado, innovaciones tecnológicas y/o cualquier otro factor, sin incurrir en ningún tipo de responsabilidad.

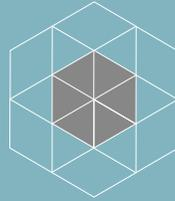

HEXAGON
LAB

APAVISA
www.apavisa.com

Ctra. Castellón – San Juan de Moró, hm.7,5 - 12130 SAN JUAN DE MORÓ (Castellón) Spain
Tel. +34 964 701 120 - Export Fax +34 964 701 067 - Fax Nacional 964 701 195 - info@apavisa.com

