

Arbi Bathroom

# Absolute

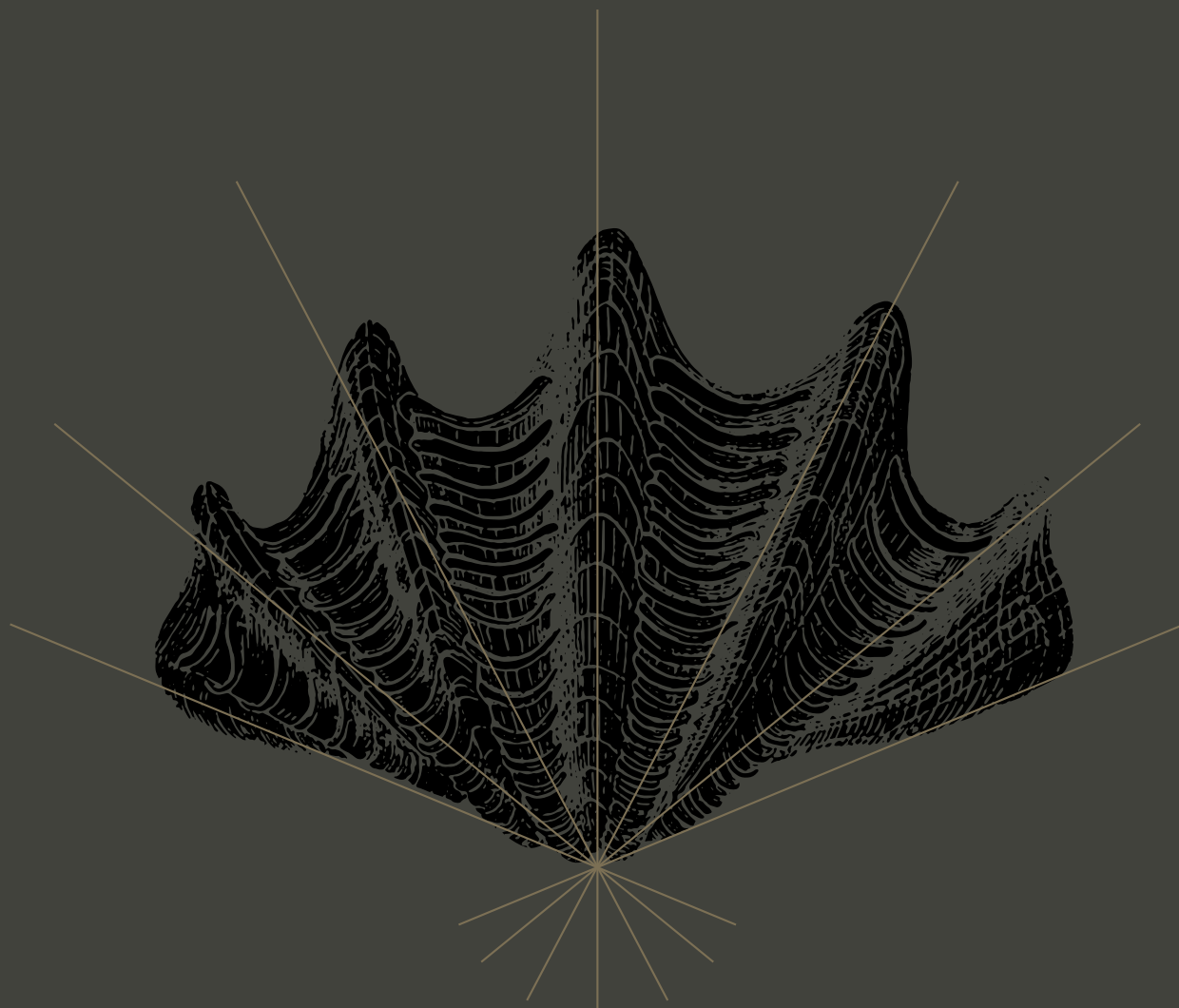



Absolute

# Absolute

**IT** Un'assoluta versatilità, per dare forma a molteplici emozioni e situazioni, con un linguaggio fatto di colori, materiali, superfici e volumi da abbinare in totale libertà, in armonia con ogni stile e situazione architettonica. **EN** An extraordinary versatility to shape many emotions and situations, thanks to a language made of colors, materials, surfaces and volumes to combine freely, in harmony with each kind of style or architecture. **FR** Une versatilité absolue conçue pour donner forme à multiples émotions et situations, grâce à un mélange de couleurs, matériaux, surfaces et volumes à combiner en liberté et en harmonie avec n'importe quel style d'architecture. **DE** Eine absolute Vielseitigkeit, die zahlreiche Emotionen und Situationen entstehen lässt, mit einer Sprache, die aus Farben, Materialien, Oberflächen und Formen gemacht ist, die völlig frei und im Einklang mit jedem Stil und jeglichen architektonischen Voraussetzungen kombiniert werden können. **RU** Абсолютная многогранность – для выражения личных эмоций и характера окружающей обстановки на языке цвета, материалов, поверхностей и форм в сочетании с полной свободой и в гармонии с любым стилем.

# Index

## Valencia

pp. 8 — 29



## Milano

pp. 30 — 55





### Paris

pp. 56 — 73



### Antibes

pp. 74 — 95



### Genève

pp. 96 — 119



### Technical

pp. 120 — 146

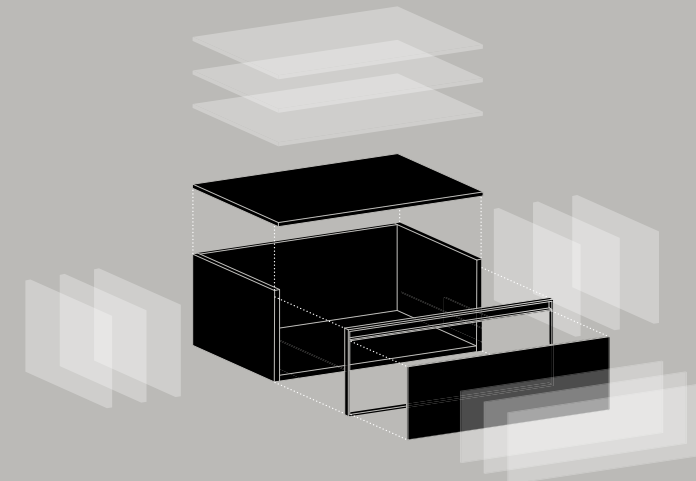

# Valencia

**IT** Spazi trasparenti e aperti sul mondo della natura, in una multiforme geometria fatta di piani sfalsati e segni verticali. Legno, ceramiche e tonalità naturali, contraddistinguono un ambiente al tempo stesso domestico e mondano. **EN** Transparent spaces open to the nature, in a multifaceted geometry composed by offset plans and vertical signs. Wood, ceramics and natural tones create a place both reserved and popular. **FR** Des espaces transparents et ouverts sur le monde de la nature créent une géométrie multiforme de plans décalés et traces verticales. Le bois, les céramiques et les tonalités naturelles caractérisent une ambiance qui est domestique et mondain en même temps. **DE** Transparente Räume, die sich hin zur Welt der Natur öffnen, in einer vielförmigen Geometrie, die aus versetzten Ebenen und vertikalen Elementen gemacht ist. Holz, Keramik und Naturtöne lassen ein Ambiente entstehen, das häuslich und mondän zugleich wirkt. **RU** Светлые и открытые пространства в мире природы, многогранной геометрии, созданной из многоуровневых поверхностей, и вертикальных акцентов. Дерево, керамика и природные натуральные оттенки характеризуют помещение не только как домашнее, но и в то же время светское.

















①

②

③

Absolute 01

1 specchiera Boheme FM (verticale) con profilo in alluminio nero /out of standard vertical mirror Boheme with black aluminium profile 2 lavabo Zen centro stanza in Gres Iris Ivory /Iris Ivory Gres washbasin Zen free standing 3 vasca Panier in Tekno opaca / Tekno matt bathtub Panier





- 1** specchiera Boheme FM (verticale) con profilo in alluminio nero /**out of standard vertical mirror Boheme with black aluminium profile** **2** lavabo Zen centro stanza in Gres Iris Ivory /**Iris Ivory Gres washbasin Zen free standing** **4** colonne con telaio nero e frontale in Rovere Spessart /**columns with black frame and frontal made of Rovere Spessart**





**5** sistema di mensole illuminanti Shine laccato Bisonte opaco /**system of shining shelves Shine in matt Bisonte finish** **6** cassettoni con telaio nero e frontale in Rovere Spessart /**big drawers with black frame and frontal made of Rovere Spessart** **7** scocca e piano top laccato Carruba opaco /**body and top matt Carruba lacquered**



①

②

③

④

⑤

Absolute 02

1 specchiera Boheme FM con profilo in alluminio nero /out of standard vertical mirror Boheme with black aluminium profile 2 lavabo Zen in Gres Florim Amani opaco /Florim Amani matt Gres washbasin Zen 3 piano folding in Rovere Spessart Sp. 12,2 cm /Rovere Spessart folding top th. 12,2 cm 4 scocca laccata nero opaco /black matt lacquered body 5 frontali con telaio nero, laccati Sahara opaco /frontals Sahara matt lacquered with black frame





**4** scocca laccata nero opaco /**black matt lacquered body** **5** frontali con telaio nero, laccati Sahara opaco /**frontals Sahara matt lacquered with black frame** **6** pensile Regolo laccato Sahara opaco /**wall unit Regolo in matt Sahara lacquered finish**





**7** colonne con telaio nero e frontali in Rovere Spessart a rombi /**columns with black frame and frontals made of Rovere Spessart with diamond effect**







1 specchiera Boheme FM con profilo in alluminio nero /out of standard vertical mirror Boheme with black aluminium profile 2 lavabo Zen in Gres Florim Amani opaco / Florim Amani matt Gres washbasin Zen 3 piano folding in Rovere Spessart Sp. 12,2 cm /Rovere Spessart folding top th. 12,2 cm 4 scocca laccata nero opaco /black matt lacquered body 5 frontali con telaio nero, laccati Sahara opaco /frontals Sahara matt lacquered with black frame



# Milano

**IT** Un senso di raffinatezza esclusiva, studiata in ogni minimo dettaglio eppure improntata a un'essenzialità rigorosa. Scenari intimi, spazi che racchiudono sensazioni preziose, prospettive affacciate su un mondo interiore. **EN** A sense of refined exclusivity, studied in each minimal detail, but also based on a strict essentiality. Intimate scenarios, spaces enclosing precious sensations, perspectives overlooking to the inner world. **FR** Une sensation de sophistication exclusive, bien détaillée mais axée sur une essentialité rigoureuse. Une scène intime, des espaces qui entourent des sensations précieuses, des perspectives qui reflètent un monde intérieur. **DE** Ein Gefühl von exklusiver Raffinesse, durchdacht bis ins kleinste Detail und zugleich ausgerichtet auf eine strenge Wesentlichkeit. Intime Szenarien, Räume, die kostbare Empfindungen umschließen, Perspektiven, die auf eine innere Welt blicken. **RU** Ощущение абсолютной изысканности, с которой была разработана каждая деталь, но тем не менее сохранившая строгость линий. Атмосфера личного пространства, наполненного бесценными ощущениями и направленного на раскрытие внутреннего мира.





## Absolute 03

1 specchiera Boheme FM con profilo in alluminio nero /out of standard mirror Boheme with black aluminium profile 2 piano in Laminam Sp. 12,2 cm in Emperador Extra lucido con doppia vasca Kuki integrata /Emperador Extra glossy Laminam top th. 12,2 cm with double integrated washbasin Kuki 3 top Sp. 1,2 cm in Lamianm Fokos Roccia /Fokos Roccia Laminam top th. 1,2 cm 4 cassettoni con telaio nero e frontale in Iron Sand /big drawers with black frame and Iron Sand frontal





- 2 piano in Laminam Sp. 12,2 cm in Emperador Extra lucido con doppia vasca Kuki integrata / **Emperador Extra glossy Laminam top th. 12,2 cm with double integrated washbasin Kuki**  
 5 sistema di mensole illuminanti Shine con specchio brunito / **system of shining shelves Shine in matt Bisonte lacquered finish** 6 vasca Belt in Tekno / **Tekno bathtub Belt**





⑦



- 2 piano in Laminam Sp. 12,2 cm in Emperador Extra lucido con doppia vasca Kuki integrata / **Emperador Extra glossy Laminam top th. 12,2 cm with double integrated washbasin Kuki** 7 colonne con telaio nero e frontale in Laminam Fokos Roccia / **columns with black frame and Fokos Roccia Laminam frontal** 8 cassetto attrezzato con divisori in vetro dark grey / **equipped drawer with dark grey glass divider**





6

6 vasca Belt in Tekno /Tekno bathtub Belt







6 vasca Belt in Tekno /Tekno bathtub Belt



Absolute 04

1 colonne in Laminam Fokos Roccia con telaio nero /Fokos Roccia Laminam columns with black frame 2 lavabo Mantra in Gres Iris Amber /Iris Amber Gres washbasin Mantra 3 frontali in Laminam Fokos Roccia con telaio nero /Fokos Roccia Laminam frontals with black frame





1 pensili in Laminam Fokos Roccia con telaio nero /**Fokos Roccia Laminam wall units with black frame**  
 2 lavabo Mantra in Gres Iris Amber /**Iris Amber Gres washbasin Mantra** 3 frontali in Laminam Fokos Roccia con telaio nero /**Fokos Roccia Laminam frontals with black frame** 4 specchiera Light con profilo nero /**Mirror Light with black profile** 5 piatto doccia in Gres Iris Amber /**Gres Iris Amber shower tray**

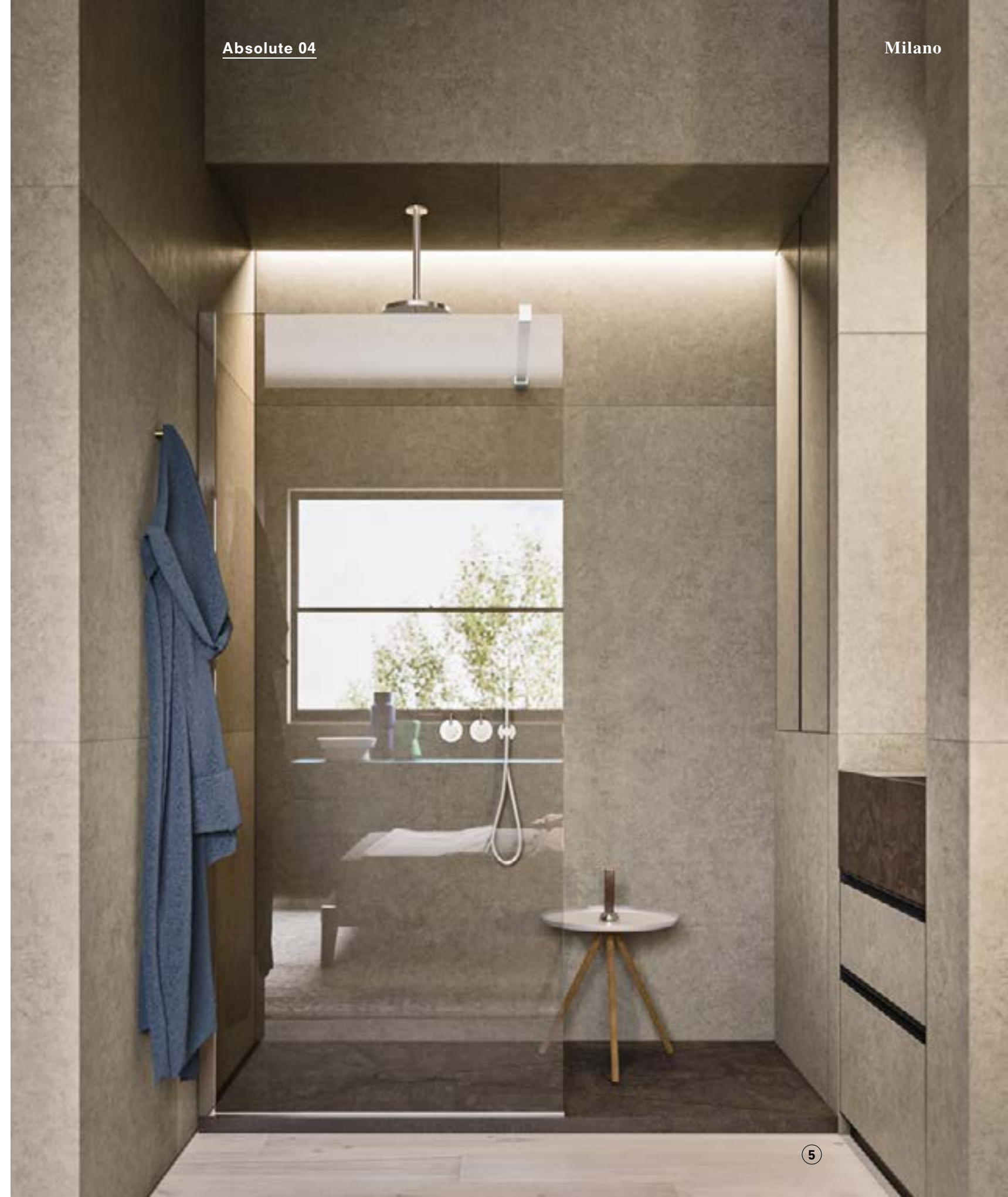





**Absolute 05**

**1** colonne con telaio nero e frontale in Rovere Spessart /**columns with black frame and Rovere Spessart frontal** **2** colonne Regolo laccate Carruba opaco /**columns Regolo in Carruba matt lacquered finish**





**3** specchiera Boheme FM con profilo in alluminio nero /**out of standard mirror Boheme with black aluminium profile** **4** piano Sp. 12,2 cm in Gres Amani opaco + alzata /**top and rise made of Amani matt Gres th. 12,2 cm** **5** lavabi Semisfera in tekno opaco /**Tekno matt washbasins Semisfera**



- 3 specchiera Boheme FM con profilo in alluminio nero /out of standard mirror Boheme with black aluminium profile 5 lavabi Semisfera in tekno opaco /Tekno matt washbasins Semisfera  
6 cassettoni con telaio nero e frontale in Rovere Spessart a rombi /big drawers with black frame and Rovere Spessart frontal with diamond effect 7 vasca Belt in Tekno /Tekno bathtub Belt





7 vasca Belt in Tekno /Tekno bathtub Belt





8

8 piatto doccia in Gres Florim Amani opaco / Florim Amani matt Gres shower tray



# Paris

**IT** La cultura contemporanea del progetto, interpreta una signorile dimora del passato. Antichi stucchi e materiali tecnologici, tonalità di tendenza e decori tradizionali, compongono un insieme estremamente sofisticato e originale. **EN** The contemporary culture of the project interprets a signature house of the past. Ancient stuccos and technological materials, trendy tones and traditional decorations, compose a sophisticated and original mix. **FR** La culture contemporaine de ce projet incarne une maison élégante d'antan. Des enduits anciens et des matériaux technologiques, des finitions de tendance et décorations traditionnelles jouent pour créer un ensemble extrêmement sophistiqué et original. **DE** Die zeitgemäße Kultur des Projekts interpretiert einen herrschaftlichen Wohnsitz der Vergangenheit. Antike Stuckarbeiten und technologische Materialien, angesagte Farbtöne und traditionelle Dekore lassen zusammen ein überaus raffiniertes und einzigartiges Gesamtergebnis entstehen. **RU** Современные культурные тенденции предписывают моду на благородные дома из прошлого. Античная лепнина и технологические материалы, модные оттенки и традиционное убранство представляют собой чрезвычайно изысканный и оригинальный ансамбль.





**Absolute 06**

- 1** specchiera Naïke FM con profilo in alluminio nero /**out of standard mirror Naïke with black profile**  
**2** piano Sp. 8 cm in fenix Bluriva /**Bluriva fenix top th. 8 cm** **3** lavabo Belt 55 in tekno /**Tekno washbasin Belt 55** **4** top Sp. 1,2 cm in Gres Iris Black Marquinia /**Black Marquinia Gres Iris top th. 1,2 cm**  
**5** frontale in vetro ondulato e telaio nero /**frontal made of wavy glass with black frame**





- 1 specchiera Naïke FM con profilo in alluminio nero /out of standard mirror Naïke with black aluminium profile 3 lavabo Belt 55 in tekno /Tekno washbasin Belt 55  
5 frontale in vetro ondulato e telaio nero /frontal made of wavy glass with black frame  
6 piatto doccia in Laminam Statuarietto opaco /Statuarietto matt Laminam shower tray

6





**2** piano Sp. 8 cm in fenix Bluriva /**Bluriva fenix top th. 8 cm** **4** top Sp. 1,2 cm  
in Gres Iris Black Marquinia /**Black Marquinia Gres Iris top th. 1,2 cm** **5** frontale  
in vetro ondulato e telaio nero /**frontal made of wavy glass with black frame**





- 1 specchiera Naïke FM con profilo in alluminio nero /out of standard mirror Naïke with black profile  
 2 piano Sp. 8 cm in fenix Bluriva /Bluriva fenix top th. 8 cm 4 top Sp. 1,2 cm in Gres Iris Black Marquinia  
 /Black Marquinia Gres Iris top th. 1,2 cm 5 frontale in vetro ondulato e telaio nero /frontal made  
 of wavy glass with black frame 6 piatto doccia in Laminam Statuarietto opaco /Statuarietto matt  
 Laminam shower tray 7 mensola Slide in alluminio nero /shelf Slide in black aluminium





8 cassetiera modello Code in Rovere Essenza  
/dresser Code made of Rovere Essenza



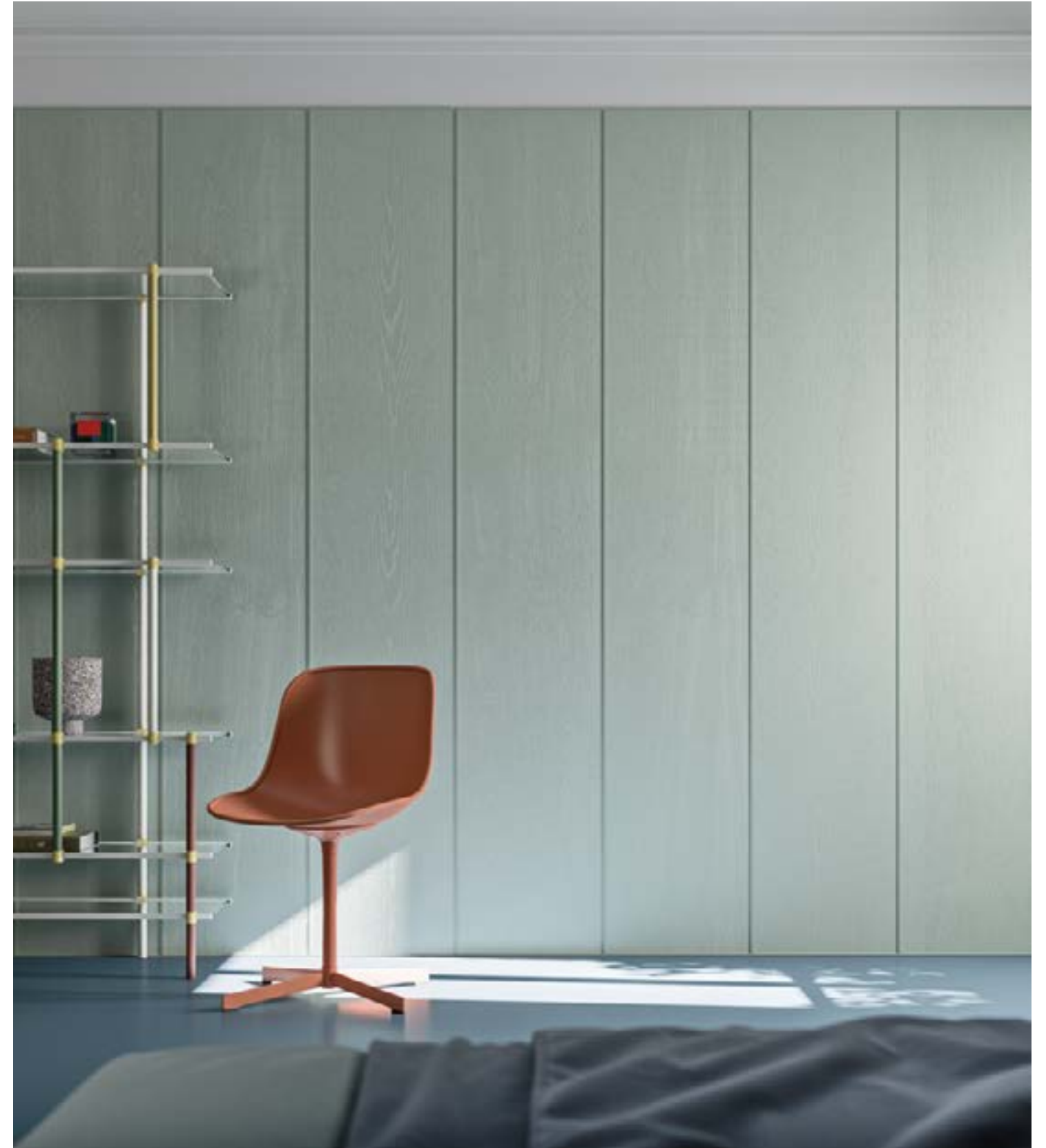





Absolute 07

1 specchiera Light /mirror Light 2 piano Sp. 1,2 cm in Laminam Bianco Assoluto /Bianco Assoluto Laminam top th. 1,2 cm 3 lavabo Beauty 40 in ceramica /ceramic washbasin Beauty 40 4 mensola Slide 70 in alluminio bianco /white aluminium shelf Slide 70 5 cassettoni con telaio bianco e frontale laccato Cachi opaco /big drawers with white frame and frontal in Cachi matt finish





1 specchiera Light /mirror Light 2 piano Sp. 1,2 cm in Laminam Bianco Assoluto /Bianco Assoluto Laminam top th. 1,2 cm 3 lavabo Beauty 40 in ceramica /ceramic washbasin Beauty 40 4 mensola Slide 70 in alluminio bianco /white aluminium shelf Slide 70 5 cassettoni con telaio bianco e frontale laccato Cachi opaco /big drawers with white frame and frontal in Cachi matt finish





# Antibes

**IT** Una casa per le vacanze in riva al mare, sospesa nel tempo fra l'intramontabile fascino dell'architettura anni '60 e un minimalismo di piacevole attualità. Luminosità mediterranea che crea contrasti decisi, come il sole di mezzogiorno. **EN** A waterfront vacation home, suspended between the never-ending charm of the architecture of the '60s and a pleasing contemporary minimalism. Mediterranean lights which create marked contrasts. **FR** Une maison pour les vacances à la mer, suspendue entre l'intemporel charme de l'architecture des années '60 et le minimalisme contemporain. Une luminosité méditerranéenne qui exalte les contrastes forts. **DE** Ein Ferienhaus am Meer, in der zeitlichen Schwebung zwischen der unvergänglichen Faszination der Architektur der 1960er-Jahre und einem angenehm aktuellen Minimalismus. Eine mediterrane Helligkeit, die starke Kontraste entstehen lässt, wie die Sonne zur Mittagszeit. **RU** Домик на берегу моря в стиле, неподвластном времени, – очарование архитектуры 60-х годов и современный минимализм. Яркость Средиземноморья, создающая контрасты, как полуденное солнце.









## Absolute 08

- 1** specchiere Tao FM con luce led perimetrale /**out of standard mirror Tao with perimeter led**  
**2** piano folding Sp.8 cm Vintage in Abete Caucaso /**Vintage Abete Caucaso folding top th. 8 cm** **3** lavabo Cuir 55 in ceramica opaca /**matt ceramic washbasin Cuir 55** **4** cassettoni con telaio e frontali bianchi opaco /**big drawers with white frame and white matt frontals**



**Absolute 09**

1 vasca Belt in tekno opaco /Tekno matt bathtub Belt







1

1 vasca Belt in Tekno /Tekno bathtub Belt





2 piatto doccia Wall in tekno resina Cemento / **Cemento Tekno shower tray Wall**





3 colonne con telaio nero e frontali Vintage in Abete Dolomiti /columns with black frame and Vintage Abete Dolomiti frontals 4 specchiera Boheme FM con profilo in alluminio nero /out of standard mirror Boheme with black aluminium profile 5 lavabi Panier 56 in ceramica opaca /Matt ceramic washbasins Panier 56 6 piano Sp. 1,2 in tekno /Tekno top th. 1,2 cm 7 cassettoni con telaio nero e frontali in specchio Brunito /big drawers with black frame and frontal with Brunito mirror





**3** colonne con telaio nero e frontali Vintage in Abete Dolomiti /**columns with black frame and Vintage Abete Dolomiti frontals** **4** specchiera Boheme FM con profilo in alluminio nero /**out of standard mirror Boheme with black aluminium profile** **5** lavabi Panier 56 in ceramica opaca /**Matt ceramic washbasins Panier 56** **6** piano Sp. 1,2 in tekno /**Tekno top th. 1,2 cm** **7** cassettoni con telaio nero e frontali in specchio Brunito /**big drawers with black frame and frontal with Brunito mirror**







**4** specchiera Boheme FM con profilo in alluminio nero /**out of standard mirror Boheme with black aluminium profile** **5** lavabi Panier 56 in ceramica opaca /**Matt ceramic washbasin Panier 56** **6** piano Sp. 1,2 in tekno /**Tekno top th. 1,2 cm** **7** cassettoni con telaio nero e frontali in specchio Brunito /**big drawers with black frame and frontal with Brunito mirror**





Absolute 10

1 mensola Slide in alluminio nero /**black aluminium shelf Slide** 2 sgabelli in alluminio nero con top laccato nero opaco /**black aluminium stools with black matt top** 3 specchiera Light Tonda ø 100 cm con luce led perimetrale /**mirror Light Tonda – ø 100 cm – with perimeter led** 4 piano Sp. 1 cm in Steel Textura con vasca integrata Plaza /**Steel Textura top h 1 cm with integrated Plaza washbasin** 5 cassettone con frontale in vetro ondulato Bianco /**big drawer made of white wavy glass frontal** 6 piano folding Sp. 8 cm Vintage in Abete Dolomiti /**Vintage Abete Dolomiti folding top th. 8 cm**







- 3** specchiera Light Tonda ø 100 con luce led perimetrale / **mirror Light Tonda – ø 100 cm – with perimeter led** **4** piano Sp. 1 cm in Steel Textura con vasca integrata Plaza / **Steel Textura top th. 1 cm with integrated Plaza washbasin** **5** cassettone con frontale in vetro ondulato Bianco / **big drawer made of white wavy glass frontal** **6** piano folding Sp. 8 cm Vintage in Abete Dolomiti / **Vintage Abete Dolomiti folding top th. 8 cm** **7** elemento Regolo laccato Bianco opaco / **White matt lacquered element Regolo**



## Genève

**IT** In questa residenza si percepisce un senso contemporaneo del lusso. Le venature del legno, le marmoree ceramiche, i bagliori del metallo, i giochi di linee, superfici e volumi, rivelano una cura sapiente e sartoriale di ogni dettaglio. **EN** In this house you can perceive the contemporary sense of luxury. Wood veins, ceramics with marble effect, brilliance of metals, games of lines, surfaces and volumes, reveal a wise and sartorial culture of each detail. **FR** Dans cette résidence on s'aperçoit du sens contemporain du luxe. Le grain du bois, les céramiques à effet marbre, les éclairs du métal, le mélange de lignes, surfaces et volume, révèlent une sage attention presque de haute couture. **DE** In diesem Anwesen nimmt man ein zeitgemäßes Gefühl von Luxus wahr. Die Maserung von Holz, das Marmorhafte von Keramik, der Glanz von Metall, das Spiel mit Linien, die Oberflächen und Formen offenbaren eine fachkundige und individuelle Gestaltung eines jeden noch so kleinen Details. **RU** В этой обстановке ощущается современная роскошь. Текстура древесины, керамический мрамор, блеск металла, игра линий, поверхностей и объемов раскрывают искусную и умелую заботу о каждой детали.



**Absolute 11**

**1** specchiera Boheme FM con profilo in alluminio nero /**out of standard mirror Boheme with black aluminium profile** **2** cassettoni con telaio nero e frontali e fianco in Laminam Pietra di Savoia Antracite /**big drawers with black frame; fronts and side in Pietra di Savoia Antracite Laminam** **3** colonne con telaio nero e frontali in Rovere Spessart /**columns with black frame and fronts in Rovere Spessart** **4** vasca Clio in tekno /**tekno bathtub Clio**







- 1 specchiera Boheme FM con profilo in alluminio nero /**out of standard mirror Boheme with black aluminium profile** 2 cassettoni con telaio nero e frontali e fianco in Laminam Pietra di Savoia Antracite /**big drawers with black frame; fronts and side in Laminam Pietra di Savoia Antracite**  
 3 colonne con telaio nero e frontali in Rovere Spessart /**columns with black frame and fronts made of Rovere Spessart** 5 piano in Laminam Sp. 1,2 cm in Pietra di Savoia Antracite con doppia vasca Plaza integrata /**Pietra di Savoia Antracite Laminam top th.1,2 cm with double integrated washbasin Plaza**





**3** cassettoni con telaio nero e frontali e fianco in Laminam Pietra di Savoia Antracite  
**/big drawers with black frame; fronts and side in Pietra di Savoia Antracite Laminam**  
**5** piano in Laminam Sp. 1,2 cm in Pietra di Savoia Antracite con doppia vasca Plaza integrata  
**/Pietra di Savoia Antracite Laminam top th.1,2 cm with double integrated washbasin Plaza**







**2** cassettoni con telaio nero e frontali e fianco in Laminam Pietra di Savoia Antracite /**big drawers with black frame; fronts and side in Laminam Pietra di Savoia Antracite** **3** colonne con telaio nero e frontali in Rovere Spessart /**columns with black frame and fronts made of Rovere Spessart**









①

③

②

Absolute 12

① specchiera Light Tonda ø 100 cm con luce led perimetrale / **mirror Light Tonda ø 100 cm with perimeter LED** ② cassettoni con telaio nero e frontali laccati Bianco opaco / **big drawers with black frame and fronts white matt lacquered** ③ lavabo Tantra in gres Iris Black Marquinia / **Gres Iris Black Marquinia washbasin Tantra**





**2** cassettoni con telaio nero e frontali laccati Bianco opaco / **big drawers with black frame and fronts white matt lacquered** **4** sistema di mensole illuminanti Shine laccato Bianco opaco / **system of shining shelves Shine white matt lacquered**









**Absolute 13**

- 1 Specchiera Zoe FM in alluminio bianco /out of standard mirror Zoe in white aluminium  
 2 piano Sp. 1,2 cm in gres Iris Bianco Venato con vasca Riga integrata /top  
 th. 1,2 cm in Gres Iris Bianco Venato with integrated washbasin Riga 3 elementi con telaio  
 bianco e frontali laccati Bianco opaco /elements with white frame and fronts White matt  
 lacquered 4 colonna Regolo laccata Ghiaccio opaco /column Regolo Ghiaccio matt lacquered





**1** Specchiera Zoe FM in alluminio bianco /out of standard mirror Zoe in white aluminium **2** piano Sp. 1,2 cm in gres Iris Bianco Venato con vasca Riga integrata /Gres Iris Bianco Venato top th.1,2 cm with integrated washbasin Riga **3** piano doccia Parallel in tekno /Tekno shower tray Parallel





- 1** Specchiera Zoe FM in alluminio bianco /**out of standard mirror Zoe in white aluminium**  
**2** piano Sp. 1,2 cm in gres Iris Bianco Venato con vasca Riga integrata /**Gres Iris Bianco Venato top th.1,2 cm with integrated washbasin Riga** **3** elementi con telaio bianco e frontali laccati Bianco opaco /**elements with white frame and fronts white matt lacquered** **4** colonna Regolo laccata Ghiaccio opaco /**column Regolo Ghiaccio matt lacquered**



**Technical.**

**Absolute**  
A modular program

---





## Absolute System

**IT** Un elegante telaio in alluminio bianco o nero, infinite composizioni cromatiche e materiche fra la scocca, in tinta o abbinamento, e il top, i frontali e i fianchi. Questo è il flessibile concetto progettuale da cui nasce Absolute.

**EN** An elegant frame in black or white aluminium, infinite chromatic and material composition between the structure, combined or to match with top, frontals and sides. This is the flexible concept of project which originated Absolute

**FR** Une élégante structure en aluminium blanc ou noir, des compositions chromatiques et de matériaux entre le caisson, assorti ou en combinaison, et le plan de toilette, les façades et les côtés: cela c'est le concept flexible du projet qui a généré Absolute.

**DE** Ein elegantes Aluminiumgestell in Schwarz-Weiß sowie unendliche Farb- und Strukturkombinationen zwischen dem Korpus, der farblich abgestimmt oder passend gestaltet sein kann, den Oberplatten, Fronten und Seitenwänden. Das ist das flexible Planungsprojekt, aus dem Absolute entstanden ist.

**RU** Элегантный алюминиевый каркас белый или черный, бесчисленный композиционный ряд из вариации отделки корпуса и столешницы, фасада и торцевых панелей. Это концепция дизайна, из которого рождается Absolute.

1 Top  
2 Scocca in  
76 varianti  
3 Telaio in  
2 finiture  
4 Frontale in  
152 varianti

1 Top  
2 Structure in  
76 finishes  
3 Frame in 2  
different finishes  
4 Frontal in  
152 finishes

1 Top  
2 Structure en  
76 finitions  
3 Cadre en  
2 finitions  
4 Frontal en  
152 finitions

1 Waschtisplatten  
2 Korpus in  
76 Varianten  
3 Alurahmen in  
2 Ausführungen  
4 Front in  
152 Varianten

1 Топ  
2 Корпус в  
76 отделках  
3 Рамка в двух  
отделках  
4 Фасад в  
152 отделках

A modular program



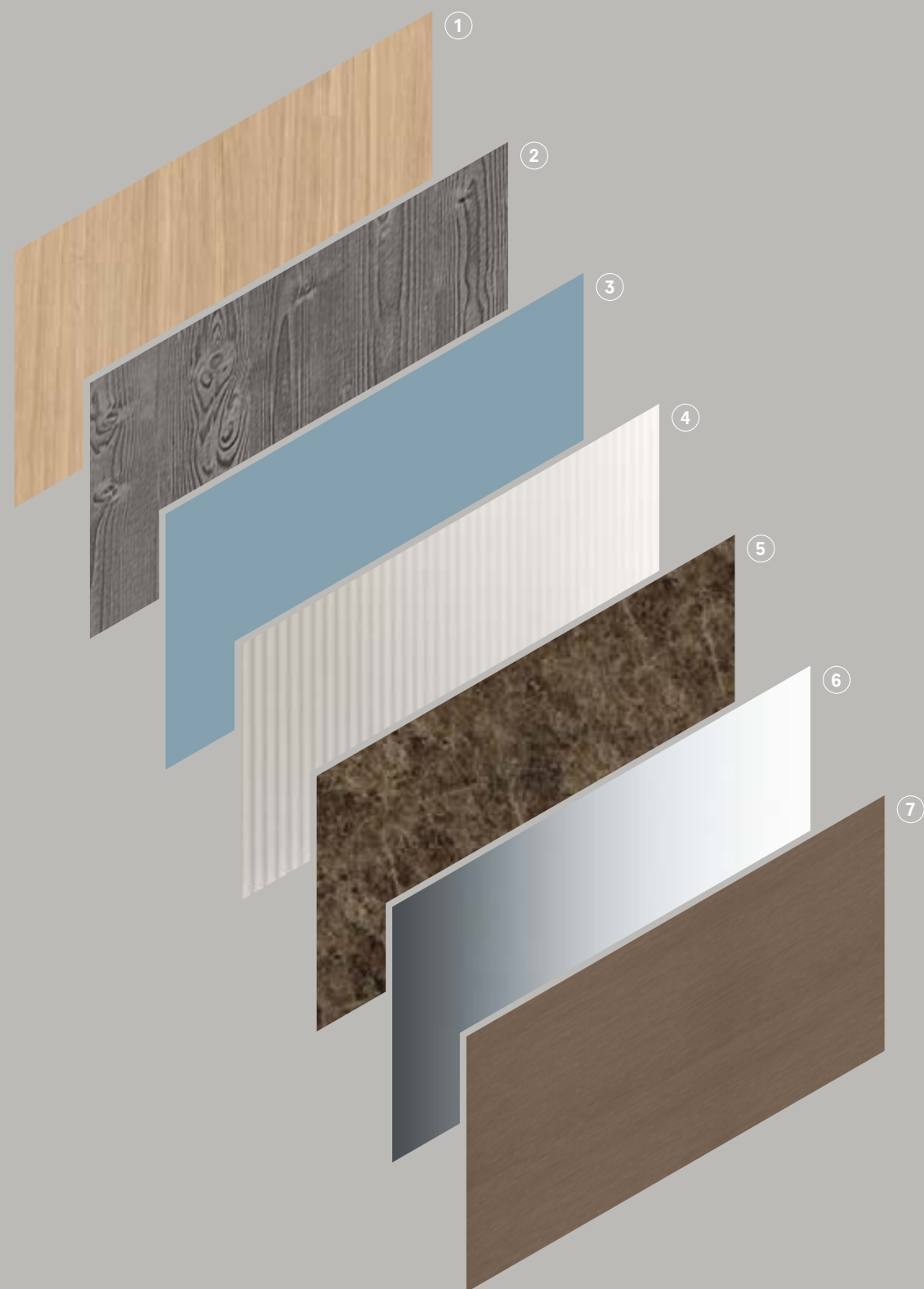

## Absolute Finishings

**IT** Le performance del termostrutturato, il calore del legno, le emozioni dei colori laccati, i riflessi del vetro, il fascino del Laminam e del Gres.

Con Absolute c'è solo il piacere della scelta, per creare soluzioni sempre uniche.

**EN** Performance of thermo-structured panel, wood warmth, emotions of lacquered finishes, glass reflects, charm of Laminam and gres. With Absolute you have the pleasure to choose, to create always unique solutions. **FR** Les performances du thermostructuré, la chaleur du bois, les émotions que les finitions laquées, les reflets du verre et le charme du Laminam et du grès transmettent. Grâce à Absolute, les opportunités pour créer des solutions qui soient toujours unique sont infinies.

**DE** Die Leistungen von thermostrukturiertem Material, die Wärme von Holz, die Emotionen der Lackfarben, die Reflexe von Glas, die Faszination von Laminam und Steinzeug. Absolute bietet viele Wahlmöglichkeiten zum Kreieren stets einzigartiger Lösungen. **RU** Выраженный характер отделки меламин, теплота дерева, восторг от разнообразия крашенных цветов, отблески от стекла, очарование отделок Laminam и Gres. С Absolute существует только удовольствие от выбора для создания уникального композиционного решения.

1 Legno Rovere	1 Oak	1 Chêne	1 Eiche	1 Дерево Дуб
2 Legno Vintage	2 Vintage wood	2 Bois effect vintage	2 Vintage Holz	2 Дерево Винтаж
3 Laccato colore	3 Lacquered	3 Laqué	3 Lackiert	3 Лакированный
4 Vetro colore	4 Coloured glass	4 Verre couleuré	4 Farbiges Glas	4 Крашенное стекло
5 Laminam e Gres	5 Laminam and Gres	5 Laminam et Gres	5 Laminam und Gres	5 Ламинам и Грэс
6 Specchio	6 Mirror	6 Miroir	6 Spiegel	6 Зеркало
7 Termo strutturato Iron	7 Thermo-structured Iron	7 Thermo-structuré Iron	7 Thermo- strukturiertem Iron	7 Термоструктуриро- ванный Iron

**A modular program**



# Absolute Modularity

**IT** Basi sospese, contenitori pensili, colonne: Absolute è un sistema completo per arredare e organizzare qualsiasi ambiente bagno ed anche altri spazi della casa, inserendosi in ogni contesto con funzionalità e trasversalità.

**EN** Hanged bases, wall units, columns: Absolute is a complete system to furnish and organize every kind of bathroom, and also other space of your home: it's easy to insert it in different contexts in a useful way.

**FR** Eléments bas, éléments hauts et colonnes: Absolute est un système complet pour meubler et organiser les salles de bains e tout autre lieu de la maison, grâce à sa fonctionnalité et transversalité qui le permettent de bien se mélanger dans n'importe quel contexte.

**DE** Wandhängende Unterschränke, Hängeschränke, Hochschränke: Absolute ist ein vollständiges System zum Einrichten und Organisieren von Badezimmern und anderen Räumen der Wohnung, das sich mit Funktionalität und Transversalität in jeden Kontext einfügt.

**RU** Подвесные модули, шкафы-контейнеры, пеналы: Absolute – это комплексная программа для оборудования и организации интерьера как ванной комнаты, так и любых других помещений в доме, в полном контексте с функциональностью и универсальностью.

- |                     |                   |                     |                     |                      |
|---------------------|-------------------|---------------------|---------------------|----------------------|
| 1 Basi porta lavabo | 1 Washbasin bases | 1 Bases sous-lavabo | 1 Waschbecken Basen | 1 Тумбы под раковину |
| 2 Basi              | 2 Bases           | 2 Bases             | 2 Unterschränke     | 2 Тумбы              |
| 3 Pensili           | 3 Hangings        | 3 Eléments hauts    | 3 Hängen            | 3 Шкафчики           |
| 4 Colonne           | 4 Columns         | 4 Colonne           | 4 Hochschränke      | 4 Пеналы             |

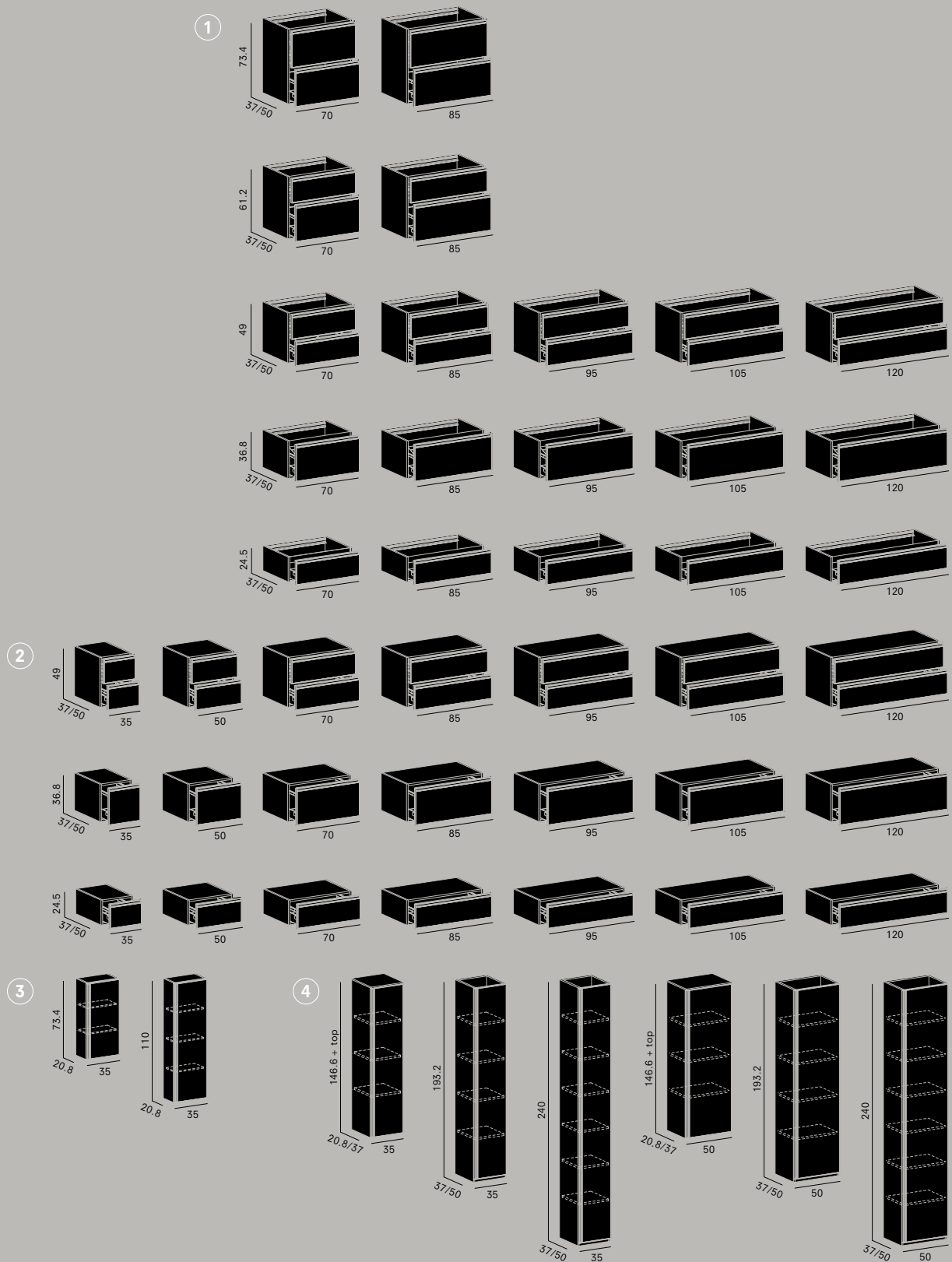

A modular program







## Legno Rovere Rovere wood

---



**831**  
Rovere  
Argilla



**823**  
Rovere  
Inchiostro



**822**  
Rovere  
Masai



**645**  
Rovere  
Spessart



**650**  
Rovere  
Spessart  
rombi



**821**  
Rovere  
Essenza



**610**  
Rovere  
Malto



**851**  
Rovere  
Tabacco



**836**  
Rovere  
Crema



**605**  
Rovere  
Castoro

## Legno vintage Vintage wood

---



**592**  
Abete  
Caucaso



**593**  
Abete  
Dolomiti

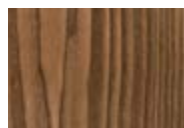

**594**  
Abete Ramato



## Termostrutturato



## Gres



## Laminam

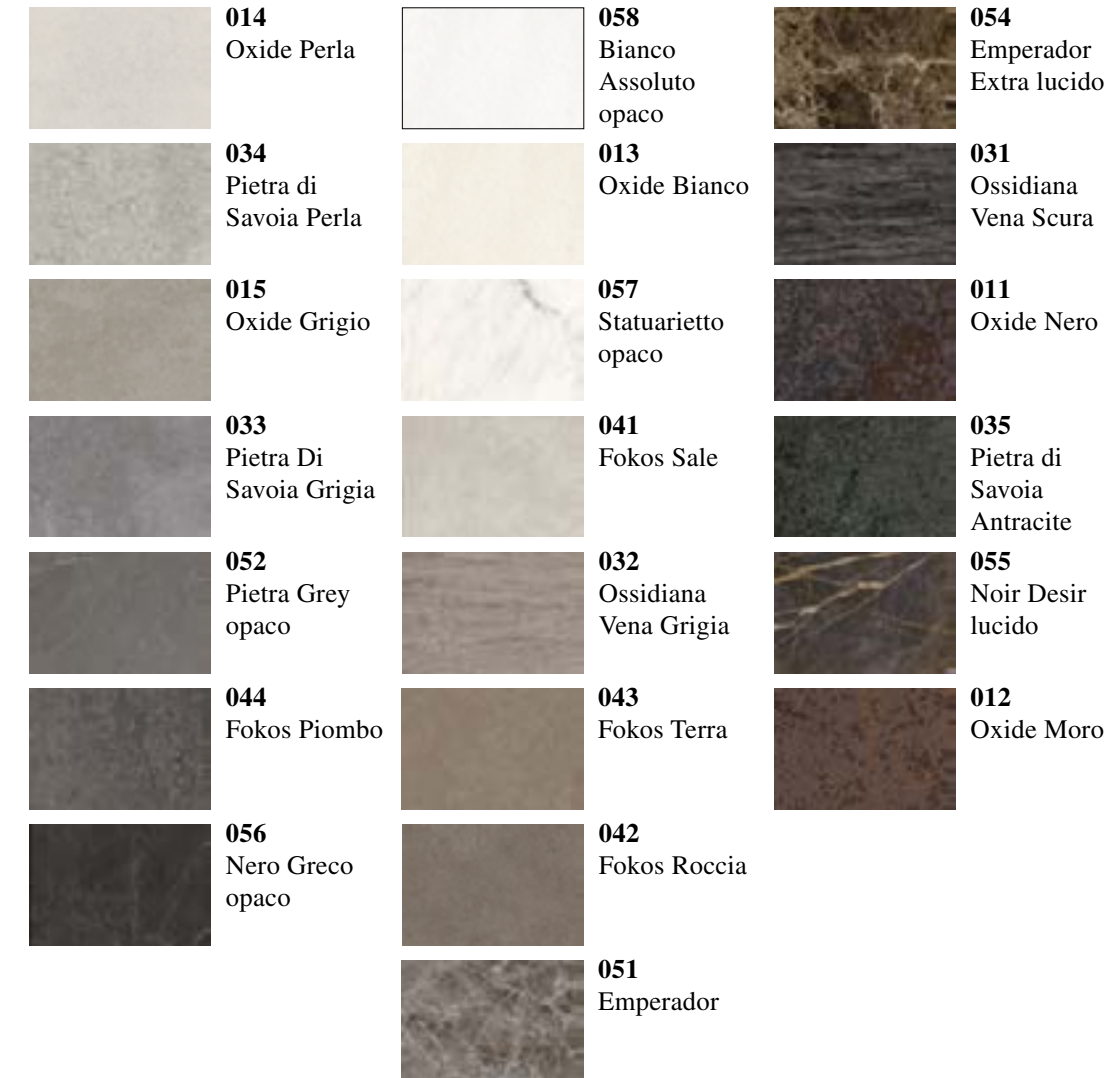









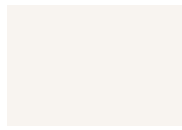
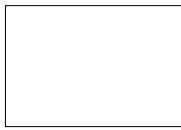

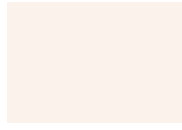



Vetro, specchio  
Glass, mirror

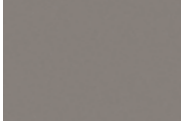

## Laccato opaco, velvet Lacquered matt, velvet

 <b>AU / V1</b> Polline	 <b>C3 / VD</b> Burro	 <b>09 / VF</b> Ecrù	 <b>CS / WK</b> Fiordo
 <b>30 / V2</b> Giallo Solare	 <b>AH / VO</b> Safari	 <b>21 / VG</b> New Pergamon	 <b>02 / W6</b> Ceruleo
 <b>C2 / V4</b> Rosso Lacca	 <b>CB / VV</b> Bisonte	 <b>C0 / VE</b> Juta	 <b>AB / W5</b> Blu Provenza
 <b>31 / V5</b> Rosso Fuoco	 <b>CA / VU</b> Terra	 <b>AG / VN</b> Corda	 <b>CU / WM</b> Bluriva
 <b>48 / V6</b> Lampone	 <b>18 / VW</b> Cacao	 <b>C9 / VS</b> Stone	 <b>C1 / VY</b> Tè Verde
 <b>CN / WF</b> Rosso Casale	 <b>27 / VX</b> Carruba	 <b>CQ / WI</b> Castoro Ottawa	 <b>AD / VB</b> Turchese
 <b>37 / V8</b> Rosso Rubino		 <b>AN / VP</b> Creta	 <b>AV / VZ</b> Petrolio
 <b>CO / WG</b> Cachi		 <b>CR / WJ</b> Grigio Londra	
 <b>CP / WH</b> Sahara		 <b>C7 / VQ</b> Cub	

## Laccato opaco, velvet Lacquered matt, velvet

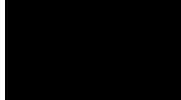
 <b>CD / W2</b> Mercurio	 <b>CF / W7</b> Sambuco	 <b>900A0 / 905V0</b> Bianco	 <b>M1</b> Metal Pinot
 <b>CE / W3</b> Blu Lapponia	 <b>C4 / VH</b> Petalo	 <b>AZ / W8</b> Ghiaccio	 <b>M2</b> Metal Magnum
 <b>CC / W0</b> Grigio Baltico	 <b>C5 / VI</b> Blush	 <b>19 / W9</b> Grigio Manhattan	 <b>M3</b> Metal Perlage
 <b>CT / WL</b> Verde Comodoro	 <b>AM / VL</b> Glicine	 <b>CV / WN</b> Grigio Efeso	
		 <b>AQ / WA</b> Cenere	
		 <b>CG / WB</b> Grigio Rabbit	
		 <b>CW / WO</b> Grigio Bromo	
		 <b>AX / WC</b> Fumo di Londra	
		 <b>26 / WD</b> Nero	

### 00 / 00

Il primo codice fa riferimento alla finitura opaca, il secondo alla finitura velvet.

First code refers to matt finish, second code refers to gloss finish.



## Absolute 01

p. 16

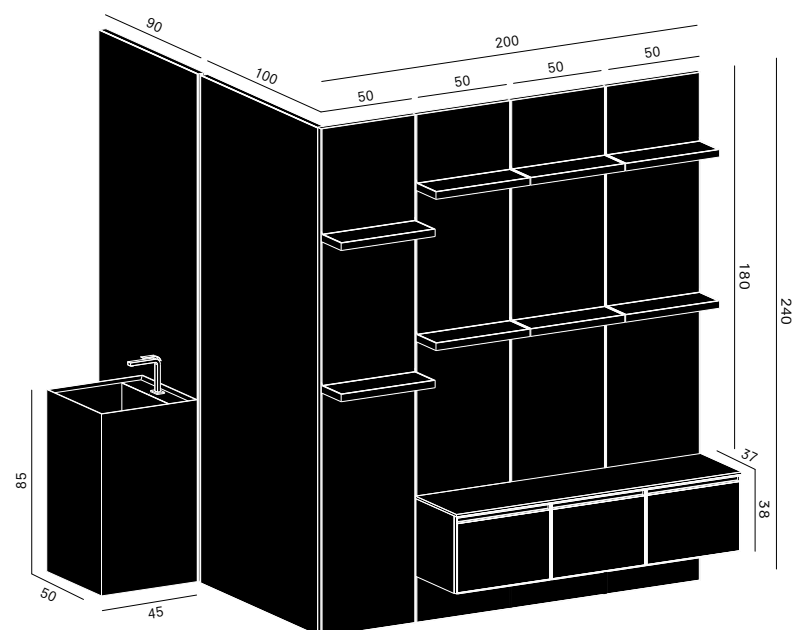

## Info tecniche

## Dimensioni

L 200 × P 37,5/3,9 cm +  
L 220 × P 45/3,9 cm

## Lavabo

Zen in Gres Iris Ivory  
L 50 × H 86 cm

## Specchiere

Boheme FM con profilo  
in alluminio nero  
L 90 + 100 × H 240 cm

## Technical info

## Dimensions

W 200 × D 37,5/3,9 +  
W 220 × D 45/3,9 cm

## Washbasin

Zen in Iris Ivory Gres  
L 50 × H 86 cm

## Mirrors

Boheme out of standard with  
black aluminium profile  
W 90 + 100 × H 240 cm

## Finiture / Finishings



**27**  
Carruba opaco



**645**  
Rovere  
Spessart



**CB**  
Bisonte opaco



**AJ**  
Gres Iris Ivory

## Absolute 02

p. 22

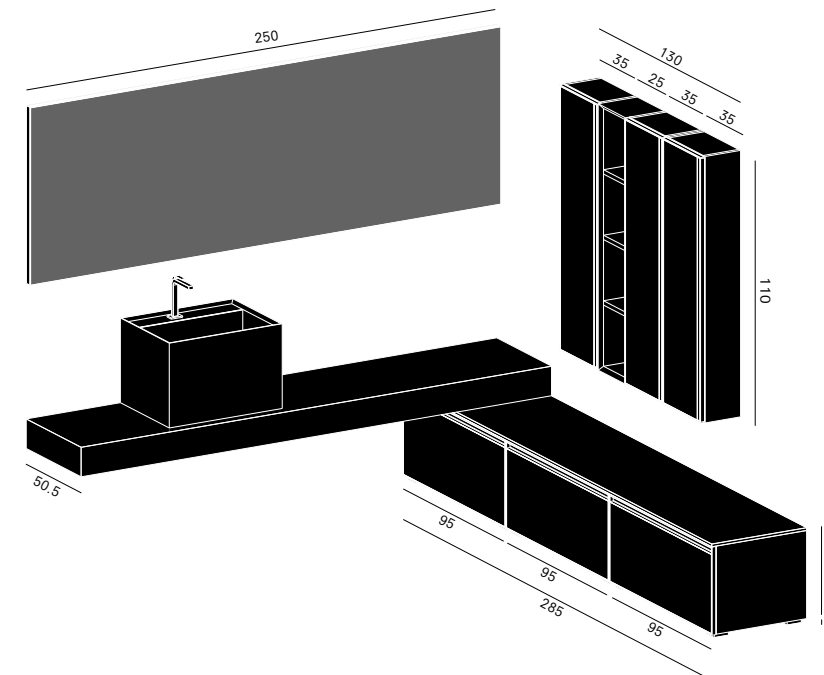

## Info tecniche

## Dimensioni

L 250 + 285,4 × P 50,5 cm

## Piano folding

SP 12,2 cm in Rovere Spessart

## Lavabo

Zen in Gres Florim Amani opaco  
L 50 × H 35 cm

## Specchiera

Boheme FM con profilo  
in alluminio nero  
L 250 × H 73,4 cm

## Technical info

## Dimensions

W 250 + 285,3 × D 50,5 cm

## Folding top

TH 12,2 cm in Rovere Spessart

## Washbasin

Zen in Florim Amani matt Gres  
L 50 × H 35 cm

## Mirror

Boheme out of standard  
with black aluminium profile  
W 250 × H 73,4 cm

## Finiture / Finishings



**26**  
Nero opaco



**CP**  
Sahara opaco



**AS**  
Gres Florim  
Amani opaco



**645**  
Rovere  
Spessart



## Absolute 03

p. 32

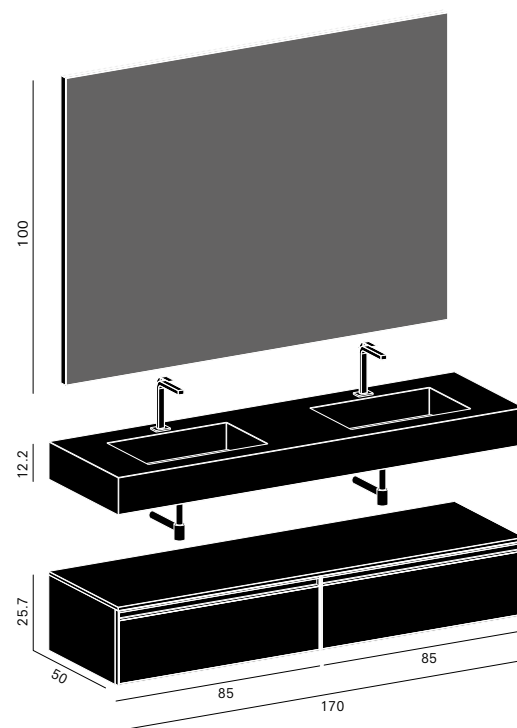

## Info tecniche

**Dimensioni**  
L 170 × P 50,5 cm

**Piano**

Laminam SP 12,2 cm  
Emperador Extra lucido  
con doppia vasca Kuki  
integrata+scivolo

**Specchiera**

Boheme FM con profilo  
in alluminio nero  
L 160 × H 100 cm

## Technical info

**Dimensions**  
W 170 × D 50,5 cm

**Top**

Emperador Extra glossy  
Laminam TH 12,2 cm with  
double integrated washbasin  
Kuki +slide

**Mirror**

Out of standard Boheme with  
black aluminium profile W 160  
× H 100 cm

## Finiture / Finishings



**M2**  
Metal  
Magnum



**AW**  
Laminam  
Emperador  
Extra lucido

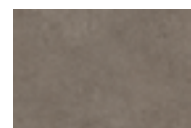

**AB**  
Fokos Roccia



**135**  
Iron Sand

## Absolute 04

p. 42

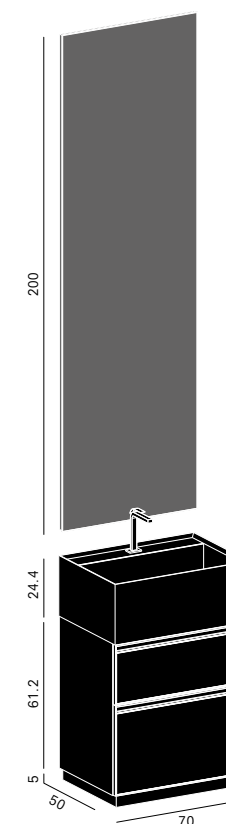

## Info tecniche

**Dimensioni**  
L 70,5 × P 50,5 cm

**Lavabo**

Mantra in Gres Iris Amber  
L 70,5 × H 24,4 cm

**Specchiera**

Light FM in alluminio nero  
L 70 × H 200 cm

## Technical info

**Dimensions**  
W 70 × D 50,5 cm

**Washbasin**

Mantra in Gres Iris Amber  
W 70 × H 24,4 cm

**Mirror**

Out of standard Light in black  
aluminium W 70 × H 200 cm

## Finiture / Finishings

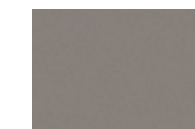

**M3**  
Metal  
Perlage



**AM**  
Gres Iris  
Amber

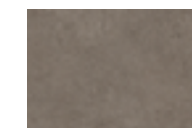

**042**  
Fokos Roccia



## Absolute 05

p. 46

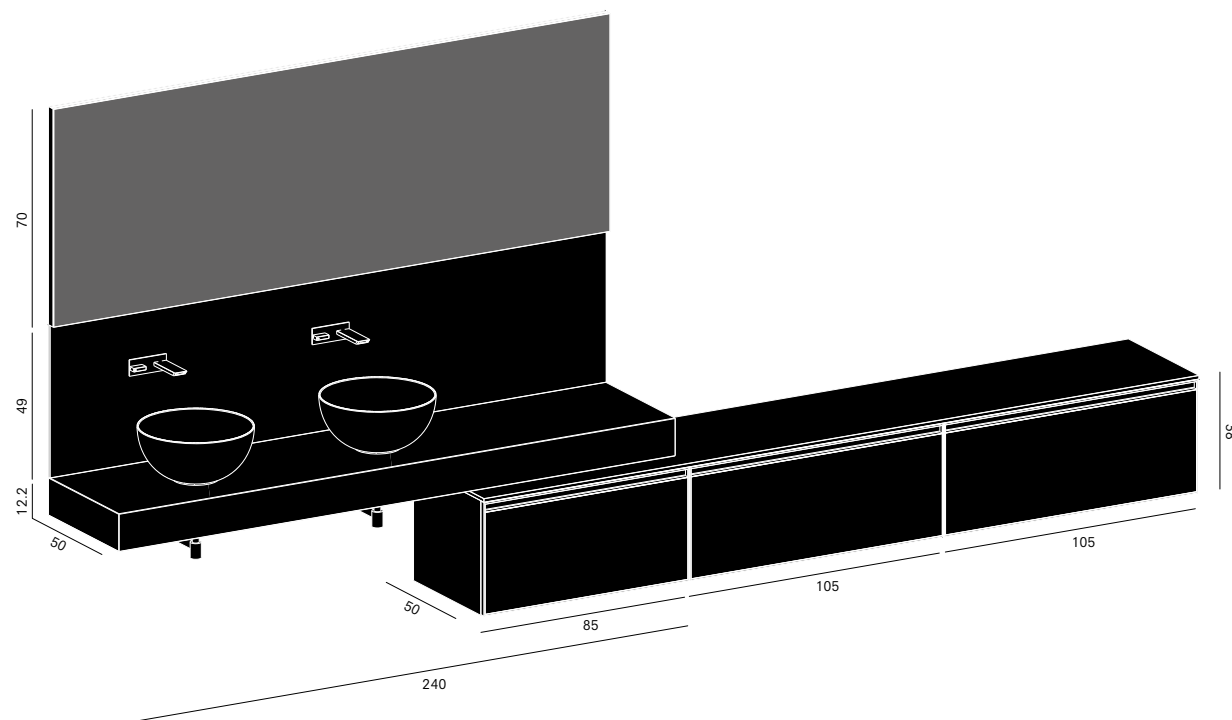

## Info tecniche

**Dimensioni**  
L 450 × P 50,5 cm

**Piano**

Gres Amani opaco SP 12,2 cm  
+ alzata incassati in nicchia  
rispetto alle basi

**Lavabi**

Semisfera in tekno

**Specchiera**

Boheme FM con profilo in  
alluminio nero L 240 × H 70 cm  
incassata in nicchia rispetto  
alle basi

## Technical info

**Dimensions**  
W 450 × D 50,5 cm

**Top**

Gres Amani matt TH 12,2 cm  
+ raise recessed in the niche  
compared to the bases

**Washbasins**

Tekno Semisfera

**Mirror**

Boheme out of standard with  
black aluminium profile  
W 240 × H 70 cm recessed in  
the niche compared to the bases

## Finiture / Finishings



**27**  
Carruba opaco



**650**  
Rovere  
Spessart  
rombi



**AS**  
Gres Florim  
Amani opaco

## Absolute 06

p. 58

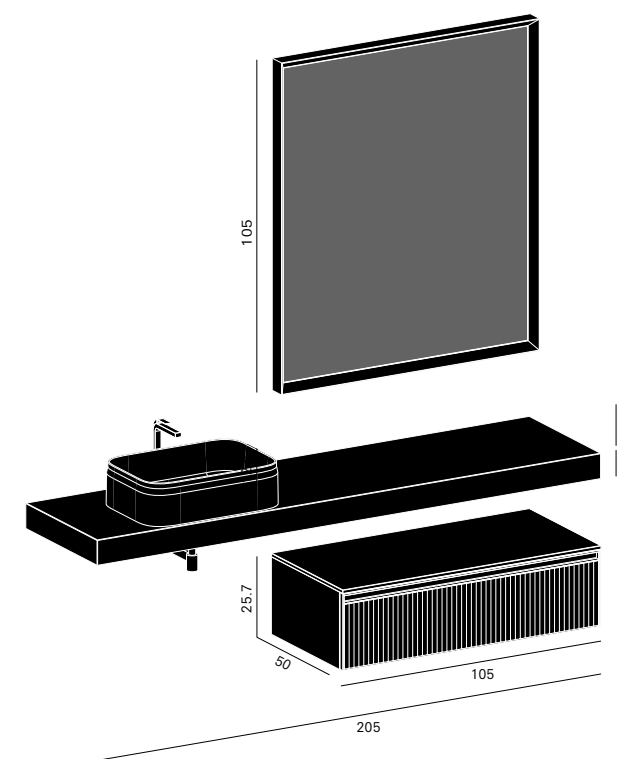

## Info tecniche

**Dimensioni**  
L 205 × P 50,5 cm

**Piano**

Fenix Bluriva SP 8 cm

**Lavabo**

Belt 55 in tekno (collezione  
Meneghello e Paoletti Associati)

**Specchiera**

Naike FM in alluminio nero  
L 105 × H 105 cm, con luce led  
perimetrale posteriore

## Technical info

**Dimensions**  
W 205 × D 50,5 cm

**Top**

Fenix Bluriva TH 8 cm

**Washbasin**

Tekno Belt 55 (collection:  
Meneghello e Paoletti Associati)

**Mirror**

Naike out of standard with black  
aluminum profile W 105 × H  
105 cm, with perimeter led

## Finiture / Finishings



**26**  
Nero opaco



**F5**  
Fenix Bluriva



**AZ**  
Gres Iris  
Black  
Marquinia

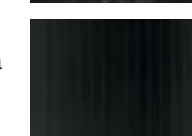

**V1026**  
Vetro nero  
ondulato



## Absolute 07

p. 70

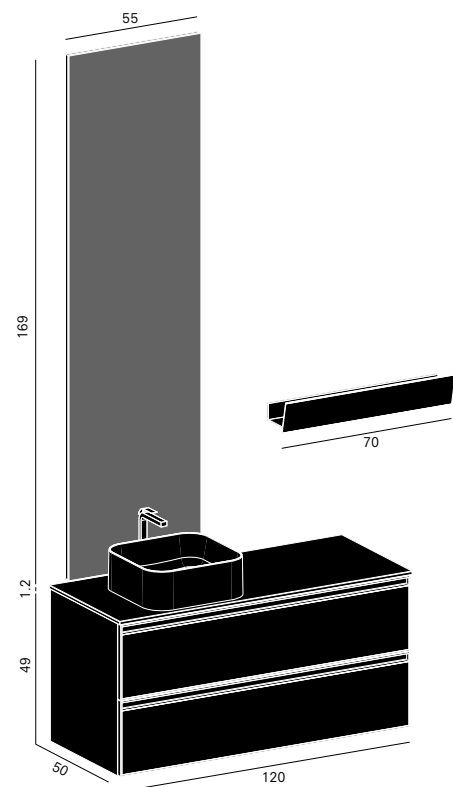

## Info tecniche

**Dimensioni**

L 120,6 × P 50,5 cm  
(L 160 cm con sporgenza mensola)

**Piano**

Laminam SP 1,2 cm  
Bianco Assoluto opaco

**Lavabo**

Beauty 40 in ceramica

**Specchiera**

Light FM L 55 × H 169 cm

## Technical info

**Dimensions**

W 120,6 × D 50,5 cm  
(L 160 cm with shelf)

**Top**

Laminam Bianco Assoluto  
matt TH 1,2 cm

**Washbasin**

Ceramic Beauty 40

**Mirror**

Light out of standard  
W 55 × H 169 cm

## Finiture / Finishings



**CO**  
Cachi opaco

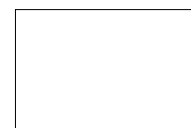

**900A0**  
Bianco opaco

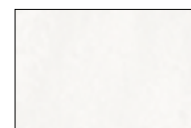

**D0**  
Laminam  
Bianco Assoluto  
opaco

## Absolute 08

p. 78

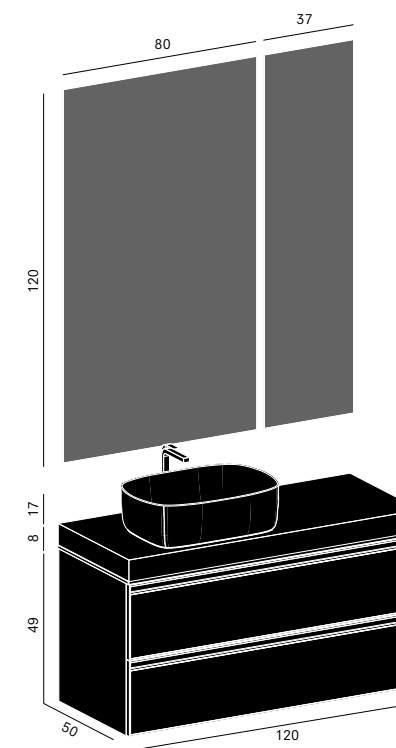

## Info tecniche

**Dimensioni**

L 120,2 × P 50,5 cm

**Piano folding**

SP 8 cm in legno Vintage  
Abete Caucaso

**Lavabo**

Cuir 55 in ceramica opaca  
(collezione Meneghello e  
Paolelli Associati)

**Specchiere**

Tao FM L 80 + 37 × H 120 cm

## Technical info

**Dimensions**

W 120,6 × D 50,5 cm

**Folding top**

TH 8 cm Vintage  
Abete Caucaso wood

**Washbasin**

Ceramic matt Cuir 55  
(collection: Meneghello e  
Paolelli Associati)

**Mirror**

Tao out of standard  
W 80 + 37 × H 120 cm

## Finiture / Finishings



**592**  
Abete  
Caucaso

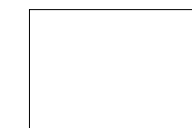

**900A0**  
Bianco opaco



## Absolute 09

p. 80

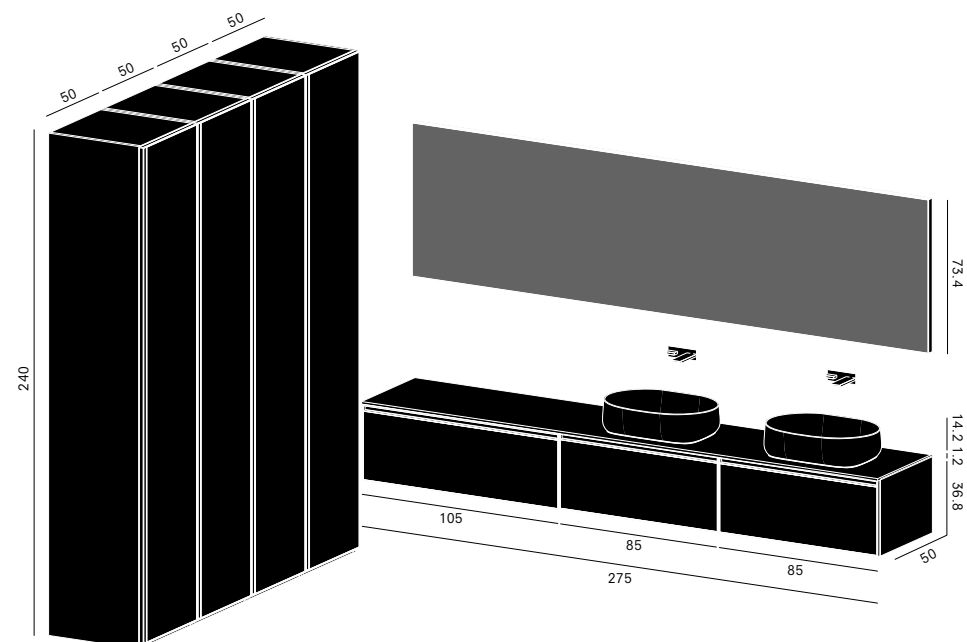

## Info tecniche

**Dimensioni**  
L 275,3 × P 50,5 cm + colonne  
L 200 × P 50 cm

**Piano**  
SP 1,2 cm in tekno bianco

**Lavabi**  
Panier 56 in ceramica opaca  
(collezione Meneghello e  
Paolelli Associati)

**Specchiera**  
Boheme FM con profilo in  
alluminio nero L 275 × H 73,4 cm

## Technical info

**Dimensions**  
W 275 × D 50,5 cm + columns  
W 200 × D 50 cm

**Top**  
TH 1,2 cm in white tekno

**Washbasins**  
Ceramic matt Panier 56  
(collection: Meneghello e  
Paolelli Associati)

**Mirror**  
Boheme out of standard  
with black aluminium frame  
W 275 × H 73,4 cm

## Finiture / Finishings



**AX**  
Fumo di  
Londra opaco



**V04**  
Specchio  
Brunito



**593**  
Abete  
Dolomiti

## Absolute 10

p. 92

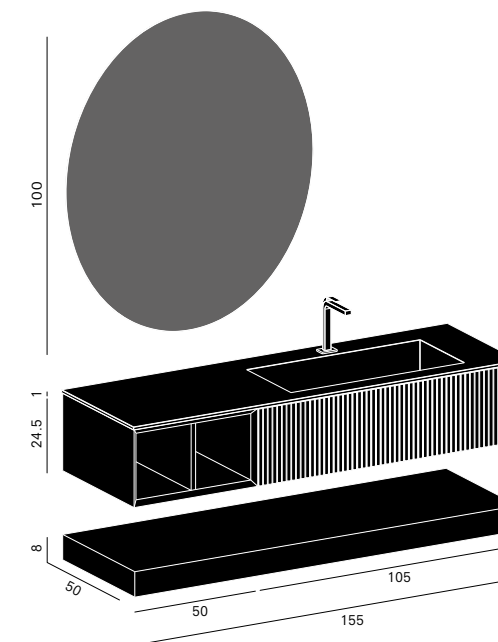

## Info tecniche

**Dimensioni**  
L 155,6 × P 50,5 cm

**Piano**  
Steel Textura SP 1 cm  
con vasca Plaza integrata

**Specchiera**  
Light Tonda Ø 100 cm  
con luce led perimetrale

## Technical info

**Dimensions**  
W 155,6 × D 50,5 cm

**Top**  
Steel Textura TH 1 cm with  
integrated washbasin Plaza

**Mirror**  
Light Tonda Ø 100 cm  
with perimeter Led

## Finiture / Finishings



**V10A0**  
Vetro bianco  
ondulato



**593**  
Abete  
Dolomiti



**900A0**  
Bianco opaco



## Absolute 11

p. 98

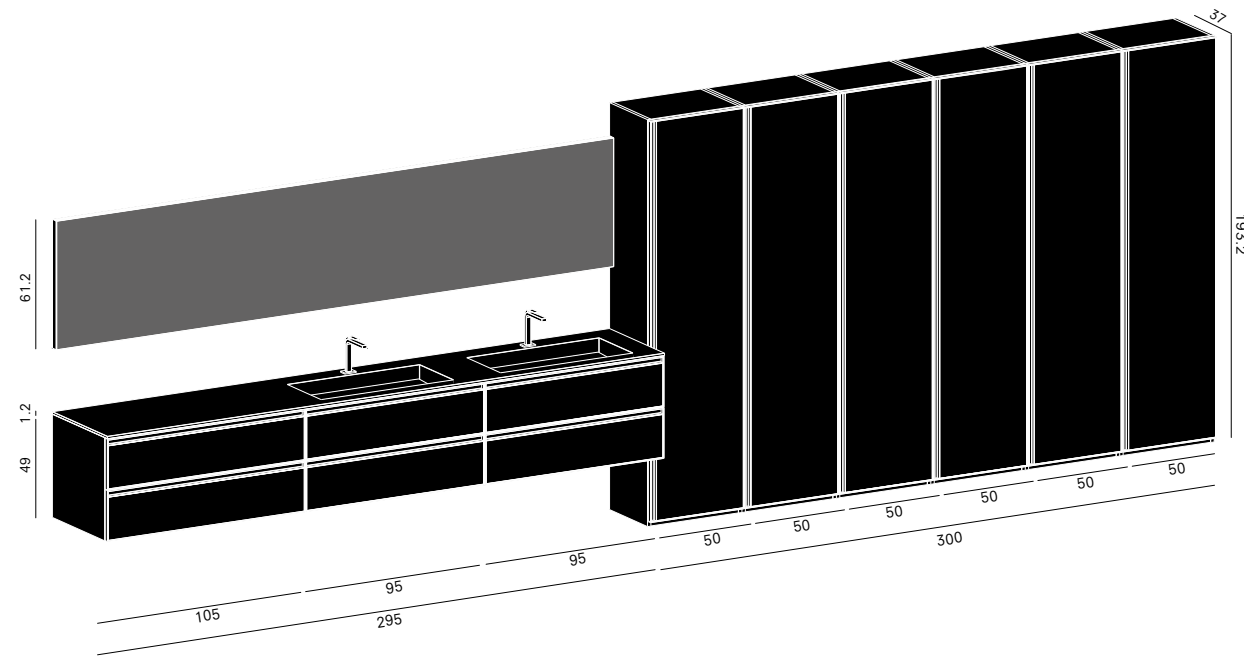

## Info tecniche

## Dimensioni

L 295 × P 50,5 cm +  
colonne L 300 cm

## Piano

Laminam SP 1,2 cm Pietra  
di Savoia Antracite con doppia  
vasca Plaza integrata + scivolo

## Specchiera

Boheme FM con profilo  
in alluminio nero  
L 295 × H 61,2 cm

## Technical info

## Dimensions

W 295 × D 50,5 cm +  
columns W 300 cm

## Top

Pietra di Savoia Antracite  
Laminam H 1,2 cm with  
double integrated washbasin  
Plaza + slide

## Mirror

Boheme out of standard with  
black aluminium profile  
L 295 × H 61,2 cm

## Finiture / Finishings



**035**  
Laminam  
Pietra di Savoia  
Antracite



**AG**  
Laminam  
Pietra di Savoia  
Antracite



**645**  
Rovere  
Spessart

## Absolute 12

p. 108

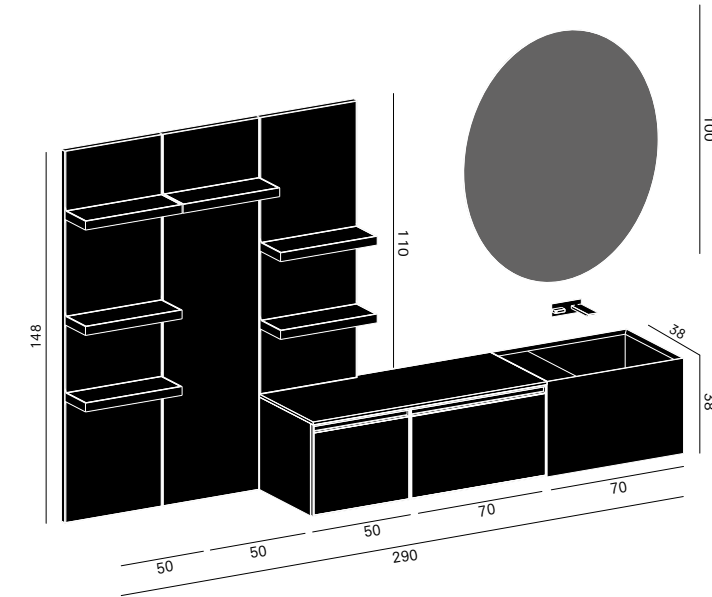

## Info tecniche

## Dimensioni

L 290 × P 20,8/38 cm

## Lavabo

Tantra in Gres Iris Black  
Marquinia L 70 × H 38 cm

## Specchiera

Light Tonda Ø 100 cm  
con luce led perimetrale

## Technical info

## Dimensions

L 290 × D 20,8/38 cm

## Washbasin

Iris Black Marquinia Gres  
Tantra W 70 × H 38 cm

## Mirror

Light Tonda Ø 100 cm  
with perimeter Led

## Finiture / Finishings



**AZ**  
Gres Black  
Marquinia

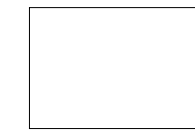

**900A0**  
Bianco opaco

## Absolute 13

p. 114

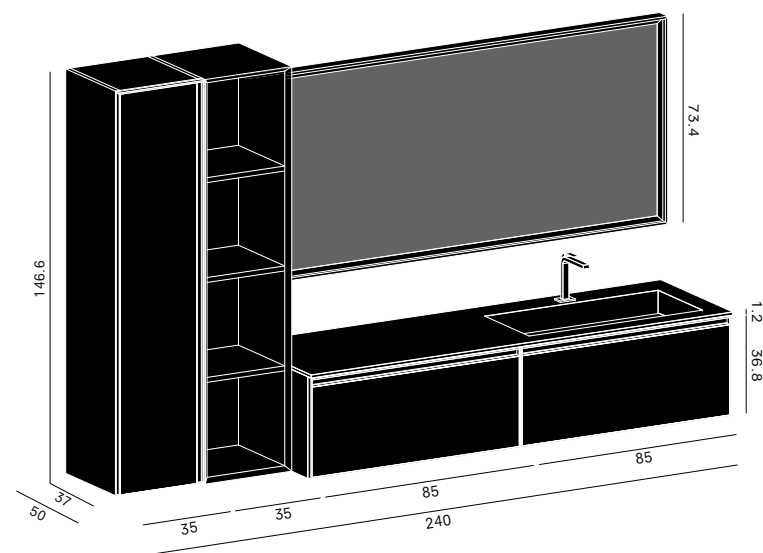
**Info tecniche****Dimensioni**

L 240,3 × P 37/50,5 cm

**Piano**Gres SP 1,2 cm Bianco Venato  
con vasca integrata Riga**Specchiera**Zoe FM in alluminio bianco  
L 170 × H 73,4 cm**Technical info****Dimensions**

W 240,3 × D 37/50,5 cm

**Top**Bianco Venato Gres TH 1,2 cm  
with integrated washbasin Riga**Mirror**Zoe out of standard with  
white alumium profile  
W 170 × H 73,4 cm**Finiture / Finishings****AO**  
Gres Bianco  
Venato opaco**AZ**  
Ghiaccio  
opaco**900A0**  
Bianco opaco



# ARBI

BATHROOM

**Arbi Arredobagno srl**  
viale Lino Zanussi 34/A  
33070 Maron di Brugnera /Italy

+39 0434 624822  
info@arbiarredobagno.it  
arbiarredobagno.it

**design**  
Ufficio Tecnico Arbi

**graphic design**  
Designwork

**concept + styling**  
Daniela Moioli  
Francesco Simoni

**immagini**  
Nudesign

**colour separation**  
Lucegroup.it

**print**  
AGCM (PN)  
October 2018

