



EDWARD

EQB DESIGN



TABELLA PREZZI FINITURE	pag. 356
INFO TECNICHE	pag. 356
INDICE / INDEX	pag. 358
LAVABO	pag. 362
BIDET	pag. 363
DOCCIA INCASSO	pag. 364
DEVIATORI INCASSO	pag. 365
DOCCIA ESTERNO	pag. 367
DOCCIA ESTERNO TERMOSTATICO	pag. 367
VASCA	pag. 368
BAGNO COMPLEMENTI	pag. 369



EDWARD

PREZZO FINITURE

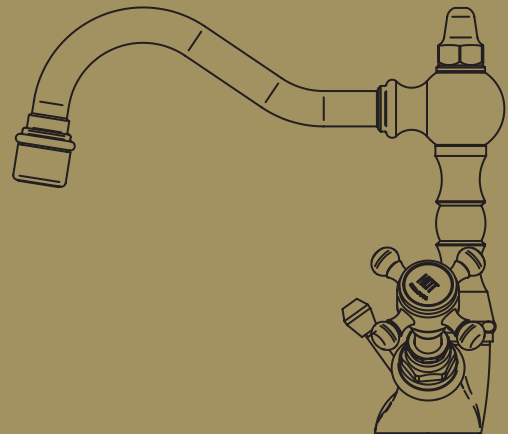
Calcola il prezzo di listino (IVA esclusa) delle finiture diverse dal cromato, consultando la seguente tabella.

Moltiplicare il **PREZZO LISTINO** per il **COEFFICIENTE MOLTIPLICATORE** della finitura scelta, arrotondando per difetto il prezzo ottenuto (eliminare i centesimi).
ESEMPIO per ordinare art. 0805/5/C in finitura dorato: codice **04-0805/5/C**

PRICE FINISHES

Include the list price (excluding VAT) of different finishes from chrome, consulting the following table. **Multiply the PRICE LIST MULTIPLIER COEFFICIENT** of the chosen finish, **reducing the price obtained by deleting the centesim.**

EXAMPLE to order art. 0805/5/C gold finish: code **04-0805/5/C**

COMPOSIZIONE CODICE PER ORDINARE ARTICOLO IN FINITURA



CODICE FINITURA
FINISH CODE

CODICE ARTICOLO
ITEM NUMBER

FINITURE DI SERIE / STANDARD FINISHES

CODICE CODE	DESCRIZIONE FINITURA FINISH DESCRIPTION	MOLTIPLICATORE MULTIPLIER
01-	cromato / chrome	PREZZO LISTINO*
02-	cromo/oro / chrome/gold	x
04-	dorato / gold	x
05-	bronzo satinato / satin bronze	x
06-	rame vecchio / old copper	x
07-	vecchio argento / old silver	x
12-	ottone lucido / polished brass	x

FINITURE A RICHIESTA / ON REQUEST FINISHES

CODICE CODE	DESCRIZIONE FINITURA FINISH DESCRIPTION	MOLTIPLICATORE MULTIPLIER
33-	cromo satinato / satin chrome	x
34-	cromo spazzolato / brushing chrome	x
35-	nickel spazzolato / brushing nickel	x
56-	avorio / ivory	x
57-	azzurro / light blue	x
58-	verdino / light green	x
59-	marrone / brown	x
60-	arancio / orange	x
61-	rosso / red	x
66-	bianco opaco / mat white	x
67-	nero opaco / mat black	x
68-	rame opaco / mat copper	x
69-	argento opaco / mat silver	x
71-	oro opaco / mat gold	x
72-	bronzo opaco / mat bronze	x
75-	dorato spazzolato / brushing gold	x
87-	oro rosa / pink gold	x
88-	ottone sisal / sisal brass	x

FINITURE A RICHIESTA / ON REQUEST FINISHES

CODICE CODE	DESCRIZIONE FINITURA FINISH DESCRIPTION	MOLTIPLICATORE MULTIPLIER
03-	oro/argento / gold/silver	x
08-	canna di fucile / gun barrel	x
10-	verderame / verdigris	x
11-	nero antracite / anthracite black	x
13-	ottone naturale / natural brass	x
14-	nero / black	x
19-	bianco / white	x
28-	nickel satinato / satin nickel	x
30-	nickel lucido / polished nickel	x

*PREZZO DI LISTINO / PRICE LIST

*NON REALIZZABILE / NOT MADE

ATTENZIONE! 13-OTTONE NATURALE e 88-OTTONE SISAL: finiture non protette che antichizzano naturalmente ossidando a contatto con l'umidità atmosferica.
WARNING! 13-NATURAL BRASS and 88-SISAL BRASS: unprotected finishes that naturally oxidise in contact with atmospheric humidity.

PROGETTO SU MISURA: RICHIESTE SPECIALI

I tecnici di Bellosta Rubinetterie sono, inoltre, a disposizione di architetti e designers, per offrire un servizio esclusivo: personalizzazioni di elementi in funzione di specifiche richieste estetiche o problematiche legate a vincoli progettuali, verifica della fattibilità attraverso opportuni studi CAD e sviluppo del disegno tecnico del prodotto speciale richiesto.

Per informazioni e richieste **PROGETTI SU MISURA:**
 ufficiotecnico@bellostarubinetterie.com



PROGETTO SU MISURA: SPECIAL REQUESTS

Engineers Bellosta Rubinetterie are also available to architects and designers, to offer an exclusive service: customizations of items according to specific aesthetic requirements or issues related to design constraints, verification of the feasibility studies and development through appropriate CAD technical design the required special product. For information and requests "SU MISURA" PROJECTS:
 ufficiotecnico@bellostarubinetterie.com

CONSIGLIO TECNICO

Tutti i miscelatori della collezione EDWARD vengono collaudati nel loro funzionamento al momento dell'assemblaggio. Per garantire la durata delle cartucce nel tempo, si consiglia di spurgare bene l'impianto idraulico prima del montaggio (per rimuovere eventuali detriti) e di installare rubinetti sottolavabo con filtro:

art. 020 o 020/1 per i monofori, art. 020 e art. 029 (tubetti di collegamento con calotta) per i tre fori.

N.B.: Qualora il piano lavabo avesse uno spessore superiore a 2,5 cm specificare la misura al momento dell'ordine.

TECHNICAL ADVICE

All mixers of the EDWARD collection are perfectly tested. To guarantee the perfect functionality of the cartridge for a long time, we advise to clean the sanitary plant before installing the mixer. Moreover we advise to install angle valve with filter:

art. 020 or 020/1 for single hole mixers, art. 020 and art. 029 (pipes with nut 1/2") for three holes mixers

Attention: If the lavatory top is more than cm 2,5 hick, please point it out when placing the order.

FORATURA DEI PIANI SANITARI

I miscelatori lavabo/bidet monoforo prevedono un foro di diametro 35 mm nel piano sanitario. Le batterie lavabo 3 fori sono dotate di vitone ceramico destro con apertura a 1/4 di giro (90°); l'interasse consigliato è di 110 mm e foratura come da schema sottostante.

MONOFORO >>

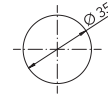

DRILLING PLANS HEALTH

The sink / hole bidet mixers provide a hole diameter of 35 mm in the health plan. The sink batteries 3 holes are equipped with ceramic cartridge Right-open 1/4 turn (90°); the recommended distance is 110 mm, drilling as per the diagram below.

3 FORI >>

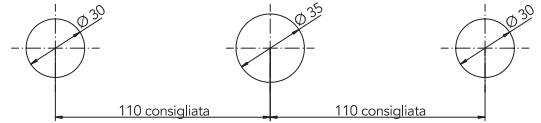

SCHEMA FUNZIONAMENTO DEVIATORI INCASSO 2/3/4 USCITE

Questi deviatori non hanno funzione di chiusura. Ruotando verso destra o sinistra si attivano le uscite. Tra 2 uscite adiacenti durante la rotazione diminuisce la portata dell'uscita iniziale ed incrementa quella della successiva. In posizione intermedia sono entrambe attive a pari portata.



2 OUT

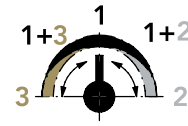

3 OUT



4 OUT

SCHEME OPERATION SWITCHES FLUSH OUTPUT 2/3/4

These diverters have not closing function. By turning to the right or left activates the outputs. Between two adjacent outputs during the rotation decreases the initial output flow and increases that of the next. In position intermediate are both active at the same flow rate.

SCHEMA DI APERTURA MISCELATORE INCASSO CON MANIGLIA A CROCE
DIAGRAM FOR OPENING BUILT-IN MIXER WITH CROSS HANDLE

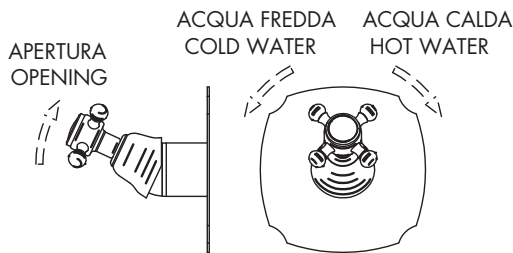

LEGENDA SIMBOLI

ACCESSORI
ACCESSORIES

- SCARICO C/TAPPO A PRESSIONE
 WASTE WITH PRESSURE CAP

RICAMBI IMMEDIATI
IMMEDIATE PARTS

- CARTUCCIA CARTRIDGE
- CARTUCCIA DEVIATRICE DIVERTER CARTRIDGE

- CARTUCCIA TERMOSTATICA THERMOSTATIC CARTRIDGE
- DEVIATORE DIVERTER

- VITONE CERAMICO CERAMIC VALVE
- AERATORE TONDO ROUND AERATOR

- VITONE TRADIZIONALE TRADITIONAL VALVE
- AERATORE PIATTO FLAT AERATOR



EDWARD

LAVABO



0805/C pag. 362
BATTERIA LAVABO TRE FORI
 3 HOLE BASIN



0805/4/C pag. 362
BATTERIA LAVABO TRE FORI BOCCA ALTA
 GIREVOLE
 3 HOLE BASIN HIGH SWINGING SPOUT



0805/1/C pag. 362
GRUPPO LAVABO MONOFORO
 1 HOLE BASIN GROUP



0805/2/C pag. 362
GRUPPO LAVABO MONOFORO BOCCA ALTA
 1 HOLE BASIN GROUP HIGH SPOUT



0805/5/C pag. 362
GRUPPO LAVABO MONOFORO BOCCA ALTA
 GIREVOLE
 1 HOLE BASIN GROUP HIGH SWINGING SPOUT



0805/6/C pag. 363
GRUPPO LAVABO MONOFORO BOCCA ALTA
 GIREVOLE
 1 HOLE BASIN GROUP HIGH SWINGING SPOUT



0805/3/C/E + 034075 pag. 363
GRUPPO LAVABO DA PARETE
 WALL BASIN GROUP

parti esterne / external parts: 0805/3/C/E
 parte incasso / built-in part: 034075



0802/C pag. 363
RUBINETTO ACQUA SINGOLA MONOFORO
 SINGLE-HOLE WATER FAUCET

BIDET



0807/7/C pag. 363
BATTERIA BIDET TRE FORI
 3 HOLE BIDET



0807/4/C pag. 363
BATTERIA BIDET TRE FORI BOCCA ALTA GIREVOLE
 3 HOLE BIDET HIGH SWINGING SPOUT



0807/C pag. 364
BATTERIA BIDET TRE FORI EROGAZIONE DA
 BORDO
 3 HOLE BIDET WITH BOARD EROGATION



0807/2/C pag. 364
GRUPPO BIDET MONOFORO
 1 HOLE BIDET GROUP



0807/5/C pag. 364
GRUPPO BIDET MONOFORO BOCCA ALTA
 GIREVOLE
 1 HOLE BIDET GROUP HIGH SPOUT



0807/6/C pag. 364
GRUPPO BIDET MONOFORO BOCCA ALTA
 GIREVOLE
 1 HOLE BIDET GROUP HIGH SWINGING SPOUT

DOCCIA INCASSO



0800/3/C/E + 084039 pag. 364
GRUPPO INCASSO C/DEVIATORE 2 USCITE
 BUILT-IN GROUP WITH DIVERTER 2 OUT

parti esterne / external parts: 0800/3/C/E
 parte incasso / built-in part: 084039



0821/M/E + 104018 pag. 365
MISCELATORE INCASSO
 BUILT-IN MIXER

parti esterne / external parts: 0821/M/E
 parte incasso / built-in part: 104018

DOCCIA INCASSO



0821/M/K/E + 104018 pag. 365

MISCELATORE INCASSO
BUILT-IN MIXER



parti esterne / external parts: 0821/M/K/E
parte incasso / built-in part: 104018



0800/M/E + 104002 pag. 365

MISCELATORE INCASSO C/DEVIATORE 2 USCITE
BUILT-IN MIXER WITH DIVERTER 2 OUT



parti esterne / external parts: 0800/M/E
parte incasso / built-in part: 104002

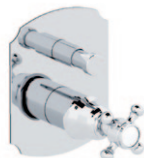

0800/M/K/E + 104002 pag. 365

MISCELATORE INCASSO C/DEVIATORE 2 USCITE
BUILT-IN MIXER WITH DIVERTER 2 OUT



parti esterne / external parts: 0800/M/K/E
parte incasso / built-in part: 104002

DEVIATORI INCASSO



0803/2/1/E + 914016 pag. 365

DEVIATORE INCASSO 2 USCITE
BUILT-IN DIVERTER 2 OUT

parti esterne / external parts: 0803/2/1/E
parte incasso / built-in part: 914016



0803/2K/E + 914016 pag. 366

DEVIATORE INCASSO 2 USCITE
BUILT-IN DIVERTER 2 OUT

parti esterne / external parts: 0803/2K/E
parte incasso / built-in part: 914016



0803/3/1/E + 034127 pag. 366

DEVIATORE INCASSO 3 USCITE
BUILT-IN DIVERTER 3 OUT

parti esterne / external parts: 0803/3/1/E
parte incasso / built-in part: 034127



0803/3K/E + 034127 pag. 366

DEVIATORE INCASSO 3 USCITE
BUILT-IN DIVERTER 3 OUT

parti esterne / external parts: 0803/3K/E
parte incasso / built-in part: 034127



0803/4/1/E + 034128 pag. 366

DEVIATORE INCASSO 4 USCITE
BUILT-IN DIVERTER 4 OUT

parti esterne / external parts: 0803/4/1/E
parte incasso / built-in part: 034128



0803/4K/E + 034128 pag. 366

DEVIATORE INCASSO 4 USCITE
BUILT-IN DIVERTER 4 OUT

parti esterne / external parts: 0803/4K/E
parte incasso / built-in part: 034128

DOCCIA INCASSO TERMOSTATICO



0812/K/E + 484020 pag. 250*

MISCELATORE TERMOSTATICO INCASSO 1 USCITA
BUILT-IN THERMOSTATIC MIXER 1 OUT

parti esterne / external parts: 0812/K/E
parte incasso / built-in part: 484020



0812/2/K/E + 484021 pag. 250*

MISCELATORE TERMOSTATICO INCASSO C/DEV 2 USCITE
BUILT-IN THERMOSTATIC MIXER WITH DIVERTER 2 OUT

parti esterne / external parts: 0812/2/K/E
parte incasso / built-in part: 484021



0812/3/K/E + 484022 pag. 250*

MISCELATORE TERMOSTATICO INCASSO C/DEV 3 USCITE
BUILT-IN THERMOSTATIC MIXER WITH DIVERTER 3 OUT

parti esterne / external parts: 0812/3/K/E
parte incasso / built-in part: 484022



0812/4/K/E + 484023 pag. 251*

MISCELATORE TERMOSTATICO INCASSO C/DEV 4 USCITE
BUILT-IN THERMOSTATIC MIXER WITH DIVERTER 4 OUT

parti esterne / external parts: 0812/4/K/E
parte incasso / built-in part: 484023

DOCCIA ESTERNO



0809/1/C pag. 367

GRUPPO DOCCIA ESTERNO
EXTERNAL SHOWER GROUP



0809/4/C pag. 367

GRUPPO DOCCIA ESTERNO C/STELO
EXTERNAL SHOWER GROUP WITH PIPE

* ABBINAMENTO CONSIGLIATO: PER PREZZI E SCHEDE TECNICHE, VEDI RIFERIMENTO PAGINA LISTINO REVIVRE

* RECOMMENDED COMBINATION: FOR PRICES AND TECHNICAL DETAILS, LOOK AT PAGE WITH REFERENCE REVIVRE PRICE

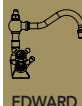

DOCCIA ESTERNO



0809/5/1/C pag. 367

GRUPPO DOCCIA ESTERNO C/STELO COMPLETO
EXTERNAL SHOWER GROUP WITH COMPLETE PIPE

DOCCIA ESTERNO TERMOSTATICO

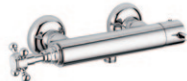

0811/1A/C pag. 367

MISCELATORE DOCCIA ESTERNO TERMOSTATICO
EXTERNAL THERMOSTATIC SHOWER MIXER



0811/4A/C pag. 368

MISCELATORE DOCCIA ESTERNO TERMOSTATICO
C/STELO
EXTERNAL THERMOSTATIC SHOWER MIXER WITH
PIPE



0811/5A/C pag. 368

MISCELATORE DOCCIA ESTERNO TERMOSTATICO
C/STELO COMPLETO
EXTERNAL THERMOSTATIC SHOWER MIXER WITH
COMPLETE PIPE

DOCCIA COMPLEMENTI



0803/1/A pag. 133*

SUPPORTO DOCCIA COMPLETO
FULL SHOWER SUPPORT



0803/1K/A pag. 133*

SUPPORTO DOCCIA COMPLETO
FULL SHOWER SUPPORT



0803/1 pag. 133*

SUPPORTO DOCCIA DUPLEX COMPLETO
FULL SHOWER SUPPORT WITH DUPLEX



0830 pag. 140*

SALISCENDI COMPLETO C/PRESA D'ACQUA
COMPLETE WALL PIPE WITH WATER CONNECTION



0830/1 pag. 145*

ASTA SALISCENDI
WALL PIPE



0513/4 pag. 149*

STELO DOCCIA
ROD SHOWER



0813/5/1 pag. 151*

CURVA PRESA ACQUA C/STELO COMPLETO
CURVE WATER CONNECTOR WITH COMPLETE ROD

VASCA



0801/6/C pag. 368

GRUPPO VASCA ESTERNO
EXTERNAL BATH GROUP



0801/4/C pag. 368

GRUPPO VASCA C/RACCORDI PER BORDO VASCA
BATH GROUP WITH RIM CONNECTION

VASCA



0801/2/C pag. 368
BATTERIA PER BORDO VASCA
BATH RIM



0801/20/C pag. 369
BATTERIA PER BORDO VASCA S/BOCCA
BATH RIM WITHOUT SPOUT

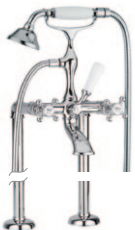

0801/40/26/C pag. 369
GRUPPO VASCA C/RACCORDI A PAVIMENTO
BATH GROUP WITH FLOOR CONNECTION



0803 pag. 369
BOCCA VASCA DA PARETE
WALL BATH SPOUT

BAGNO COMPLEMENTI



0808/CH/E + 034034 pag. 369
RUBINETTO D'ARRESTO 1/2"
BUILT-IN STOP COCK 1/2"

parti esterne / external parts: 0808/CH/E
 parte incasso / built-in part: 034034 DX



0808/CC/E + 034034 pag. 369
RUBINETTO D'ARRESTO 1/2"
BUILT-IN STOP COCK 1/2"

parti esterne / external parts: 0808/CC/E
 parte incasso / built-in part: 034034 DX



0808/CH/E + 034036 pag. 369
RUBINETTO D'ARRESTO 3/4"
BUILT-IN STOP COCK 3/4"

parti esterne / external parts: 0808/CH/E
 parte incasso / built-in part: 034036 DX



0808/CC/E + 034036 pag. 369
RUBINETTO D'ARRESTO 3/4"
BUILT-IN STOP COCK 3/4"

parti esterne / external parts: 0808/CC/E
 parte incasso / built-in part: 034036 DX



0840/E + 884053 pag. 370
PASSO RAPIDO 3/4"
BUILT-IN RAPID FLOW COCK 3/4"

parti esterne / external parts: 0840/E
 parte incasso / built-in part: 884053



0840/K/E + 884053 pag. 370
PASSO RAPIDO 3/4"
BUILT-IN RAPID FLOW COCK 3/4"

parti esterne / external parts: 0840/K/E
 parte incasso / built-in part: 884053



0840/E + 884054 pag. 370
PASSO RAPIDO 1"
BUILT-IN RAPID FLOW COCK 1"

parti esterne / external parts: 0840/E
 parte incasso / built-in part: 884054



0840/K/E + 884054 pag. 370
PASSO RAPIDO 1"
BUILT-IN RAPID FLOW COCK 1"

parti esterne / external parts: 0840/K/E
 parte incasso / built-in part: 884054



0832/2/E + 035212 pag. 370
SARACINESCA
GATE VALVE

parti esterne / external parts: 0832/2/E
 parte incasso / built-in part: 035212



0832/2/K/E + 035212 pag. 371
SARACINESCA
GATE VALVE

parti esterne / external parts: 0832/2/E
 parte incasso / built-in part: 035212

B-TRONIC - RUBINETTI ELETTRONICI



0805/4/S/EL pag. 605
MISCELATORE CON ATTIVATORE INFRAROSSO
LAVABO
BASIN MIXER WITH INFRARED ACTIVATOR



0805/C

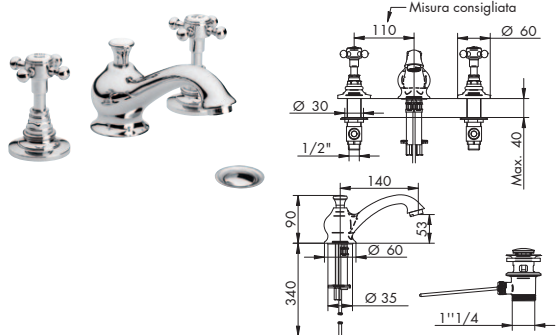

BATTERIA LAVABO TRE FORI

- > vitone ceramico 90°
- > interasse bocca 140
- > senza flessibili di alimentazione
- > con scarico
- > maniglia a croce

-  035046 p. 150
-  034005 p. 140

CROMATO		ALTRE FINITURE	
01-0805/C	€	XX-0805/C	€ x M*

0805/4/C

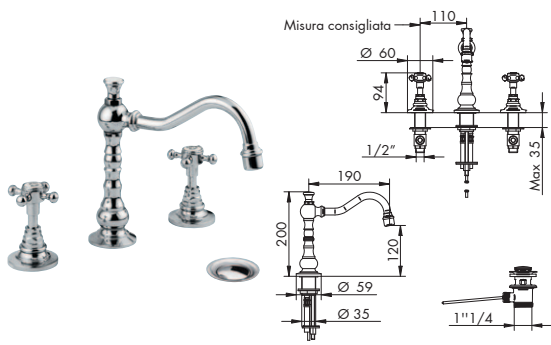

BATTERIA LAVABO TRE FORI ALTA GIREVOLE

- > vitone ceramico 90°
- > interasse bocca 190
- > bocca girevole 360°
- > senza flessibili di alimentazione
- > con scarico
- > maniglia a croce

-  035046 p. 150
-  034013 p. 140

CROMATO		ALTRE FINITURE	
01-0805/4/C	€	XX-0805/4/C	€ x M*

0805/1/C

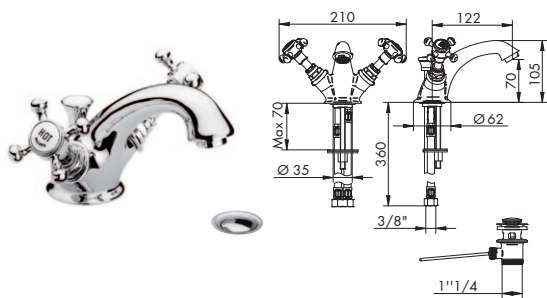

GRUPPO LAVABO MONOFORO

- > vitone ceramico 90°
- > interasse bocca 122
- > flessibili di alimentazione
- > con scarico
- > maniglia a croce

-  035046 p. 150
-  034005 p. 140

CROMATO		ALTRE FINITURE	
01-0805/1/C	€	XX-0805/1/C	€ x M*

0805/2/C

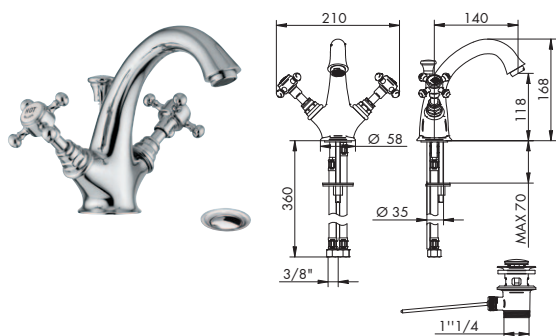

GRUPPO LAVABO MONOFORO BOCCA ALTA

- > vitone ceramico 90°
- > interasse bocca 140
- > flessibili di alimentazione
- > con scarico
- > maniglia a croce

-  035046 p. 150
-  034005 p. 140

CROMATO		ALTRE FINITURE	
01-0805/2/C	€	XX-0805/2/C	€ x M*

0805/5/C

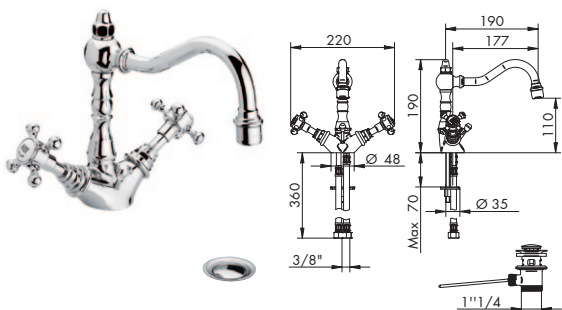

GRUPPO LAVABO MONOFORO BOCCA ALTA GIREVOLE

- > vitone ceramico 90°
- > interasse bocca 177
- > bocca girevole 360°
- > flessibili di alimentazione
- > con scarico
- > maniglia a croce

-  035046 p. 150
-  034013 p. 140

CROMATO		ALTRE FINITURE	
01-0805/5/C	€	XX-0805/5/C	€ x M*

0805/6/C

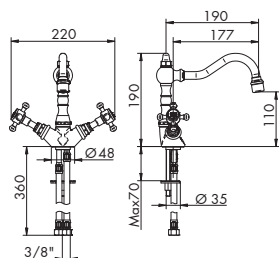

GRUPPO LAVABO MONOFORO BOCCA ALTA

GIREVOLE

- > vitone ceramico 90°
- > interasse bocca 177
- > bocca girevole 360°
- > flessibili di alimentazione
- > senza scarico
- > maniglia a croce



CROMATO

01-0805/6/C

€

ALTRE FINITURE

XX-0805/6/C

€

x M*

0805/3/C/E + 034075

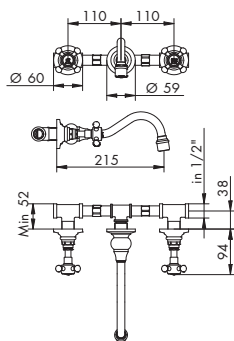

GRUPPO LAVABO DA PARETE

- > vitone ceramico 90°
- > interasse bocca 215
- > attacchi da 1/2"
- > senza scarico



PARTI ESTERNE - CROMATO

01-0805/3/C/E

€

PARTI ESTERNE - ALTRE FINITURE

XX-0805/3/C/E

€

x M*

PARTE INCASSO

034075

info pag. 31

€

PREZZO TOTALE

€

0802/C

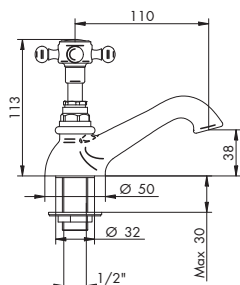

RUBINETTO ACQUA SINGOLA MONOFORO

- > vitone ceramico 90°
- > interasse bocca 110
- > uscita libera senza aeratore
- > ingresso da 1/2"
- > senza scarico
- > maniglia a croce

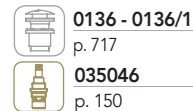

CROMATO

01-0802/C

€

ALTRE FINITURE

XX-0802/C

€

x M*

0807/7/C

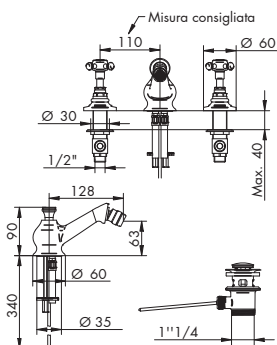

BATTERIA BIDET TRE FORI

- > vitone ceramico 90°
- > interasse bocca 128
- > aeratore snodato
- > senza flessibili di alimentazione
- > con scarico
- > maniglia a croce



CROMATO

01-0807/7/C

€

ALTRE FINITURE

XX-0807/7/C

€

x M*

0807/4/C

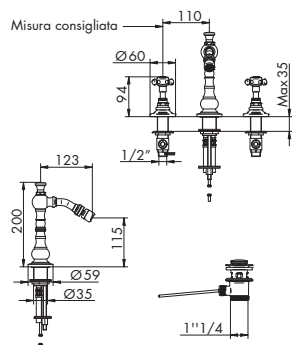

BATTERIA BIDET TRE FORI BOCCA ALTA

GIREVOLE

- > vitone ceramico 90°
- > interasse bocca 123
- > bocca girevole 360°
- > aeratore snodato
- > senza flessibili di alimentazione
- > con scarico
- > maniglia a croce



CROMATO

01-0807/4/C

€

ALTRE FINITURE

XX-0807/4/C

€

x M*

ACCESSORI

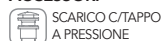

SCARICO C/TAPPO A PRESSIONE

RICAMBI IMMEDIATI



VITONE CERAMICO



AERATORE TONDO

XX = CODICE FINITURA RICHIESTA: per identificare codice corretto vedi pag. 356
 M* = MOLTIPLICATORE: per calcolare il prezzo delle altre finiture vedi tabella pag. 356

0807/C

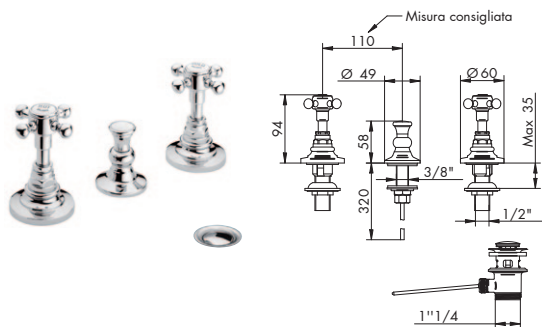

BATTERIA BIDET TRE FORI

- > vitone ceramico 90°
- > senza bocca
- > per ceramica con erogazione da bordo
- > senza flessibili di alimentazione
- > con scarico
- > maniglia a croce

035046
p. 150

CROMATO	ALTRE FINITURE
01-0807/C €	XX-0807/C € x M*

0807/2/C

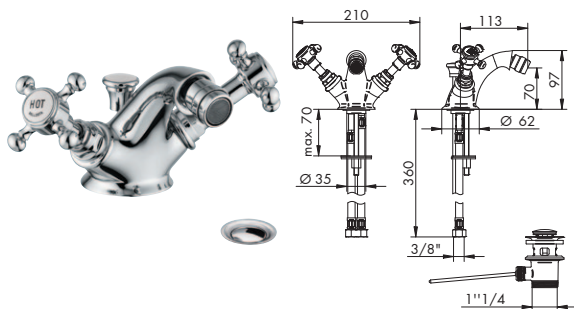

GRUPPO BIDET MONOFORO

- > vitone ceramico 90°
- > interasse bocca 113
- > aeratore snodato
- > flessibili di alimentazione
- > con scarico
- > maniglia a croce

035046
p. 150

034008
p. 140

CROMATO	ALTRE FINITURE
01-0807/2/C €	XX-0807/2/C € x M*

0807/5/C

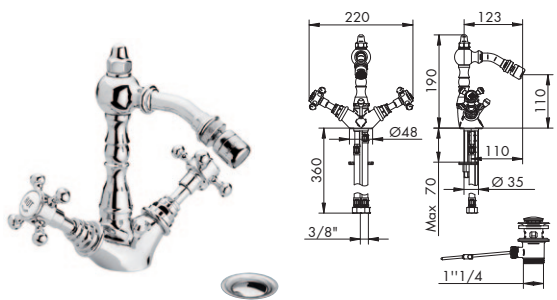

GRUPPO BIDET MONOFORO BOCCA ALTA GIREVOLE

- > vitone ceramico 90°
- > interasse bocca 110
- > bocca girevole 360°
- > aeratore snodato
- > flessibili di alimentazione
- > con scarico
- > maniglia a croce

035046
p. 150

074001
p. 140

CROMATO	ALTRE FINITURE
01-0807/5/C €	XX-0807/5/C € x M*

0807/6/C

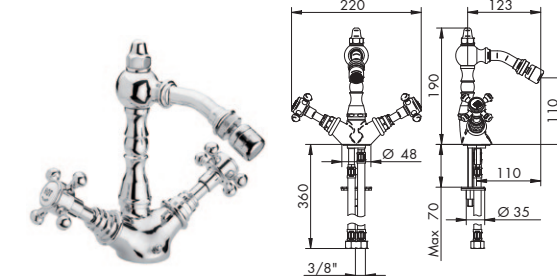

GRUPPO BIDET MONOFORO BOCCA ALTA GIREVOLE

- > vitone ceramico 90°
- > interasse bocca 110
- > bocca girevole 360°
- > aeratore snodato
- > flessibili di alimentazione
- > senza scarico
- > maniglia a croce

0136 - 0136/1
p. 717

035046
p. 150

074001
p. 140

CROMATO	ALTRE FINITURE
01-0807/6/C €	XX-0807/6/C € x M*

0800/3/C/E + 084039

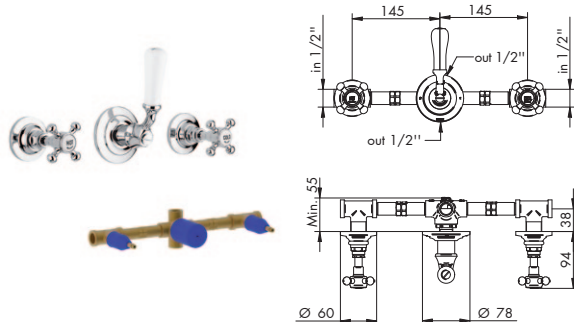

GRUPPO INCASSO C/DEVIATORE 2 USCITE

- > vitone ceramico 90°
- > deviatore a dischi ceramici 2 uscite senza chiusura
- > maniglia a croce
- > attacchi da 1/2"

035046
p. 150

635010
p. 131

035346 fino 9.2017
p. 131

PARTI ESTERNE - CROMATO	PARTI ESTERNE - ALTRE FINITURE
01-0800/3/C/E €	XX-0800/3/C/E € x M*
PARTE INCASSO	
01-084039 info pag. 35 €	
PREZZO TOTALE €	

0821/M/E + 104018

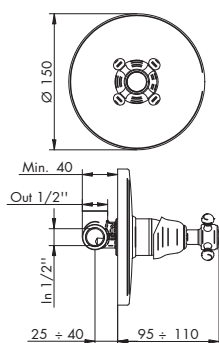

MISCELATORE INCASSO

- > cartuccia tradizionale
- > attacchi da 1/2"
- > uscita superiore
- > incasso con B-Box
- > maniglia a croce



PARTI ESTERNE - CROMATO

01-0821/M/E €

PARTI ESTERNE - ALTRE FINITURE

XX-0821/M/E € x M*

PARTE INCASSO

01-104018 info pag. 36 €

PREZZO TOTALE €

0821/M/K/E + 104018

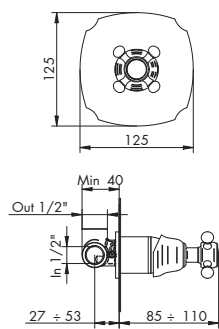

MISCELATORE INCASSO

- > cartuccia tradizionale
- > attacchi da 1/2"
- > uscita superiore
- > incasso con B-Box
- > maniglia a croce
- > piastra classic



PARTI ESTERNE - CROMATO

01-0821/M/K/E €

PARTI ESTERNE - ALTRE FINITURE

XX-0821/M/K/E € x M*

PARTE INCASSO

01-104018 info pag. 36 €

PREZZO TOTALE €

0800/M/E + 104002

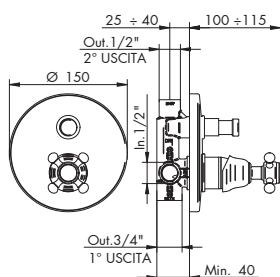

MISCELATORE INCASSO C/DEVIATORE

- > cartuccia tradizionale
- > deviatore a pressione 2 uscite c/ritorno automatico e blocco meccanico basse pressioni
- > attacchi da 1/2"
- > uscita principale inferiore da 3/4"
- > incasso con B-Box
- > maniglia a croce

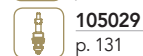

PARTI ESTERNE - CROMATO

01-0800/M/E €

PARTI ESTERNE - ALTRE FINITURE

XX-0800/M/E € x M*

PARTE INCASSO

01-104002 info pag. 37 €

PREZZO TOTALE €

0800/M/K/E + 104002

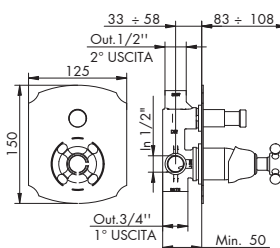

MISCELATORE INCASSO C/DEVIATORE

- > cartuccia tradizionale
- > deviatore a pressione 2 uscite c/ritorno automatico e blocco meccanico basse pressioni
- > attacchi da 1/2"
- > uscita principale inferiore da 3/4"
- > incasso con B-Box > piastra classic
- > maniglia a croce

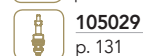

PARTI ESTERNE - CROMATO

01-0800/M/K/E €

PARTI ESTERNE - ALTRE FINITURE

XX-0800/M/K/E € x M*

PARTE INCASSO

01-104002 info pag. 37 €

PREZZO TOTALE €

0803/2/1/E + 914016

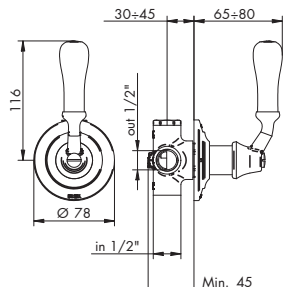
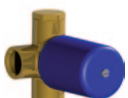

DEVIATORE INCASSO 2 USCITE

- > deviatore a dischi ceramici 2 uscite senza chiusura
- > attacchi da 1/2"
- > leva con inserto in porcellana

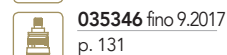

PARTI ESTERNE - CROMATO

01-0803/2/1/E €

PARTI ESTERNE - ALTRE FINITURE

XX-0803/2/1/E € x M*

PARTE INCASSO

914016 info pag. 38 €

PREZZO TOTALE €

RICAMBI IMMEDIATI



XX = CODICE FINITURA RICHIESTA: per identificare codice corretto vedi pag. 356
 M* = MOLTIPLICATORE: per calcolare il prezzo delle altre finiture vedi tabella pag. 356

0803/2K/E + 914016

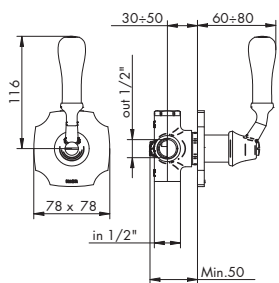

DEVIATORE INCASSO 2 USCITE

- > deviatore a dischi ceramici 2 uscite senza chiusura
- > attacchi da 1/2"
- > leva con inserto in porcellana
- > piastra classic

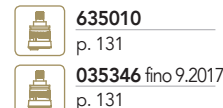

PARTI ESTERNE - CROMATO	
01-0803/2K/E	€
PARTE INCASSO	
914016	info pag. 38 €
PREZZO TOTALE	€

PARTI ESTERNE - ALTRE FINITURE	
XX-0803/2K/E	€ x M*

0803/3/1/E + 034127

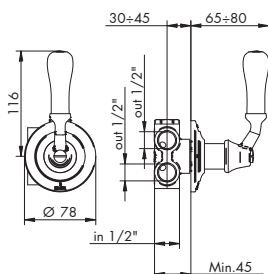

DEVIATORE INCASSO 3 USCITE

- > deviatore a dischi ceramici 3 uscite senza chiusura
- > attacchi da 1/2"
- > leva con inserto in porcellana

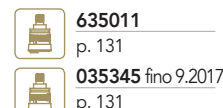

PARTI ESTERNE - CROMATO	
01-0803/3/1/E	€
PARTE INCASSO	
034127	info pag. 38 €
PREZZO TOTALE	€

PARTI ESTERNE - ALTRE FINITURE	
XX-0803/3/1/E	€ x M*

0803/3K/E + 034127

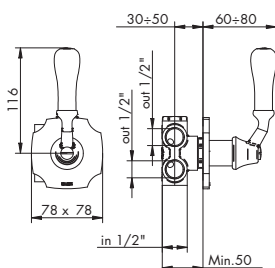

DEVIATORE INCASSO 3 USCITE

- > deviatore a dischi ceramici 3 uscite senza chiusura
- > attacchi da 1/2"
- > piastra classic
- > leva con inserto in porcellana

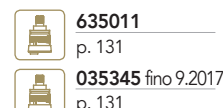

PARTI ESTERNE - CROMATO	
01-0803/3K/E	€
PARTE INCASSO	
034127	info pag. 38 €
PREZZO TOTALE	€

PARTI ESTERNE - ALTRE FINITURE	
XX-0803/3K/E	€ x M*

0803/4/1/E + 034128

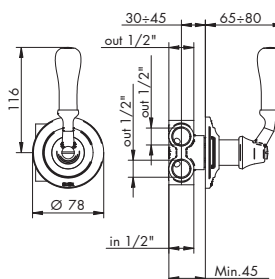

DEVIATORE INCASSO 4 USCITE

- > deviatore a dischi ceramici 4 uscite senza chiusura
- > attacchi da 1/2"
- > leva con inserto in porcellana



PARTI ESTERNE - CROMATO	
01-0803/4/1/E	€
PARTE INCASSO	
034128	info pag. 38 €
PREZZO TOTALE	€

PARTI ESTERNE - ALTRE FINITURE	
XX-0803/4/1/E	€ x M*

0803/4K/E + 034128

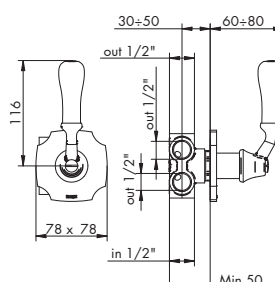

DEVIATORE INCASSO 4 USCITE

- > deviatore a dischi ceramici 4 uscite senza chiusura
- > attacchi da 1/2"
- > piastra classic
- > leva con inserto in porcellana

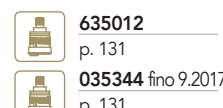

PARTI ESTERNE - CROMATO	
01-0803/4K/E	€
PARTE INCASSO	
034128	info pag. 38 €
PREZZO TOTALE	€

PARTI ESTERNE - ALTRE FINITURE	
XX-0803/4K/E	€ x M*

I DOCCIA INCASSO TERMOSTATICO CONSIGLIATI SONO PRESENTI SU LISTINO REVIVRE

0812/K/E + 484020
 0812/2/K/E + 484021
 0812/3/K/E + 484022
 0812/4/K/E + 484023

I DOCCIA COMPLEMENTI CONSIGLIATI SONO PRESENTI SU LISTINO REVIVRE

0803/1/A 0830/1
 0803/1K/A 0513/4
 0803/1 0813/5/1
 0830

0809/1/C

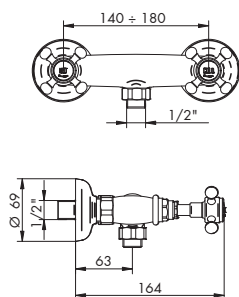

GRUPPO DOCCIA ESTERNO

- > vitone ceramico 90°
- > senza set doccia
- > attacchi da 1/2"
- > maniglia a croce

035046
p. 150

CROMATO

01-0809/1/C

€

ALTRE FINITURE

XX-0809/1/C

€

x M*

0809/4/C

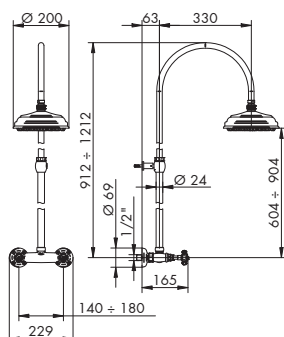

GRUPPO DOCCIA ESTERNO C/STELO

- > vitone ceramico 90°
- > stelo regolabile
- > soffione orientabile Ø200 in ottone senza anticalcare
- > attacchi da 1/2"
- > maniglia a croce

035046
p. 150

CROMATO

01-0809/4/C

€

ALTRE FINITURE

XX-0809/4/C

€

x M*

0809/5/1/C

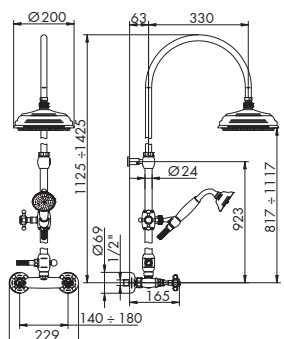

GRUPPO DOCCIA ESTERNO C/STELO COMPLETO

- > vitone ceramico 90°
- > stelo regolabile
- > deviatore a trazione c/ritorno automatico e blocco meccanico bassa pressione
- > soffione in ottone senza anticalcare
- > flessibile in ottone 150 cm
- > attacchi da 1/2"
- > doccetta monogetto in metallo senza anticalcare manico in porcellana Ø77
- > supporto doccetta scorrevole
- > maniglia a croce

035046
p. 150

035303
p. 130

CROMATO

01-0809/5/1/C

€

ALTRE FINITURE

XX-0809/5/1/C

€

x M*

0811/1A/C

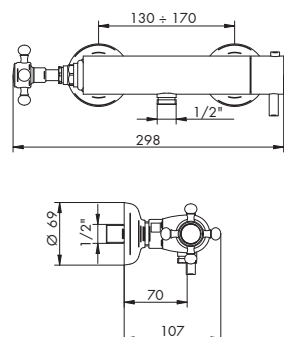

MISCELATORE DOCCIA ESTERNO TERMOSTATICO

- > cartuccia termostatica
- > vitone ceramico 90°
- > senza set doccia
- > attacchi da 1/2"
- > maniglia a croce

885041
p. 150

034041
p. 150

CROMATO

01-0811/1A/C

€

ALTRE FINITURE

XX-0811/1A/C

€

x M*

RICAMBI IMMEDIATI

VITONE CERAMICO CARTUCCIA TERMOSTATICA DEVIATORE

XX = CODICE FINITURA RICHIESTA: per identificare codice corretto vedi pag. 356
 M* = MULTIPLICATORE: per calcolare il prezzo delle altre finiture vedi tabella pag. 356

0811/4A/C

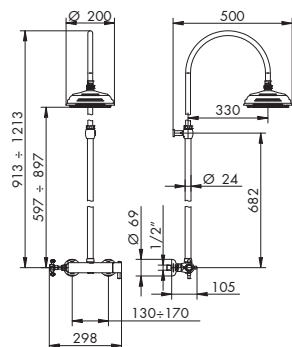

MISCELATORE DOCCIA ESTERNO TERMOSTATICO C/STELO

- > cartuccia termostatica
- > stelo regolabile
- > soffione orientabile Ø200 in ottone senza anticalcare
- > attacchi da 1/2"
- > maniglia a croce

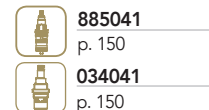

CROMATO

01-0811/4A/C

€

ALTRE FINITURE

XX-0811/4A/C

€

x M*

0811/5A/C

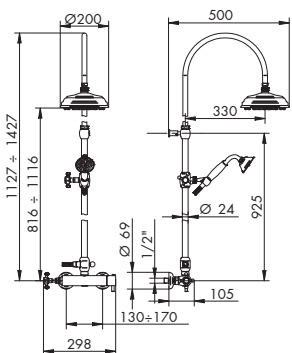

MISCELATORE DOCCIA ESTERNO TERMOSTATICO C/STELO COMPLETO

- > cartuccia termostatica
- > deviatore a trazione c/ritorno automatico e blocco meccanico bassa pressione
- > soffione Ø200 in ottone senza anticalcare
- > flessibile in ottone 150 cm
- > attacchi da 1/2"
- > doccetta monogetto in metallo senza anticalcare manico in porcellana Ø77
- > stelo regolabile
- > supporto doccetta scorrevole
- > maniglia a croce

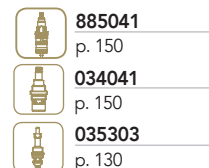

CROMATO

01-0811/5A/C

€

ALTRE FINITURE

XX-0811/5A/C

€

x M*

0801/6/C

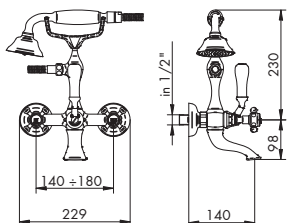

GRUPPO VASCA ESTERNO

- > vitone ceramico 90°
- > uscita libera senza areatore
- > Interasse bocca 140
- > deviatore manuale senza ritorno automatico
- > flessibile in metallo 150 cm
- > attacchi da 1/2"
- > doccetta monogetto in metallo senza anticalcare manico in porcellana Ø77

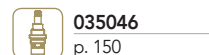

CROMATO

01-0801/6/C

€

ALTRE FINITURE

XX-0801/6/C

€

x M*

0801/4/C

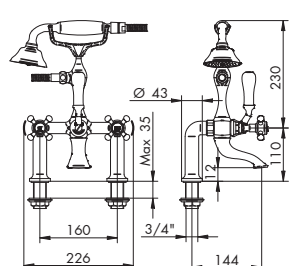

GRUPPO VASCA C/RACCORDI PER BORDO VASCA

- > vitone ceramico 90°
- > uscita libera senza areatore
- > Interasse bocca 144
- > deviatore manuale senza ritorno automatico
- > flessibile in metallo 150 cm
- > attacchi da 3/4"
- > maniglia a croce
- > doccetta monogetto in metallo senza anticalcare manico in porcellana Ø77

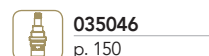

CROMATO

01-0801/4/C

€

ALTRE FINITURE

XX-0801/4/C

€

x M*

0801/2/C

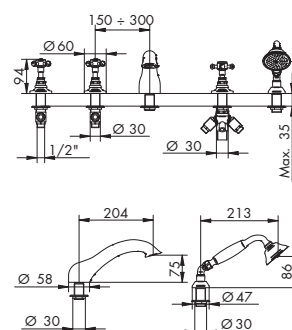

BATTERIA PER BORDO VASCA

- > vitone ceramico 90°
- > uscita libera senza areatore
- > Interasse bocca 204
- > deviatore a dischi ceramici 2 uscite
- > flessibile in metallo 150 cm
- > senza scarico
- > maniglia a croce
- > doccetta monogetto in metallo senza anticalcare manico in porcellana Ø77
- > PREDISPOSIZIONI per bordo vasca, art. 012/5, 012/6 e 012/7, vedi pag. 615

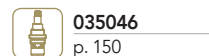

CROMATO

01-0801/2/C

€

ALTRE FINITURE

XX-0801/2/C

€

x M*



CARTUCCIA TERMOSTATICA



VITONE CERAMICO



DEVIATORE

0801/20/C

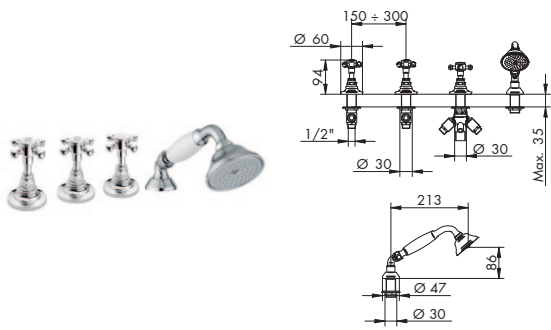

BATTERIA PER BORDO VASCA S/BOCCA

- > vitone ceramico 90°
- > senza bocca
- > deviatore a dischi ceramici 2 uscite
- > flessibile in metallo 150 cm
- > senza flessibili di alimentazione
- > senza scarico
- > maniglia a croce
- > doccetta monogetto in metallo senza anticalcare manico in porcellana Ø77
- > PREDISPOSIZIONI per bordo vasca, art. 012/4, 012/6 e 012/7, vedi pag. 615

035046
p. 150

CROMATO	ALTRE FINITURE
01-0801/20/C €	XX-0801/20/C € x M*

0801/40/26/C

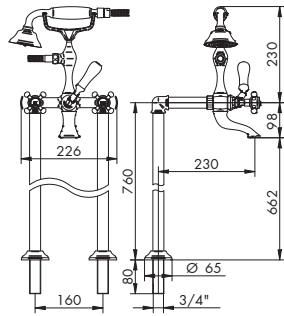

GRUPPO VASCA C/RACCORDI A PAVIMENTO

- > vitone ceramico 90°
- > uscita libera senza areatore
- > interasse bocca 230
- > deviatore manuale senza ritorno automatico
- > flessibile in metallo 150 cm
- > attacchi da 3/4"
- > maniglia a croce
- > doccetta monogetto in metallo senza anticalcare manico in porcellana Ø77
- > PREDISPOSIZIONI per gruppo vasca c/raccordi a pavimento, art. 084058, vedi pag. 734

035046
p. 150

CROMATO	ALTRE FINITURE
01-0801/40/26/C €	XX-0801/40/26/C € x M*

0803

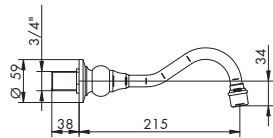

BOCCA VASCA DA PARETE

- > interasse bocca 215
- > attacco da 3/4"

034013
p. 140

CROMATO	ALTRE FINITURE
01-0803 €	XX-0803 € x M*

0808/CH/E | 0808/CC/E + 034034 DX

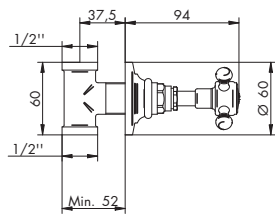

RUBINETTO D'ARRESTO 1/2"

- > vitone ceramico 90°
- > maniglia a croce "HOT" (per art. 0808/CH/E)
- > maniglia a croce "COLD" (per art. 0808/CC/E)
- > ingressi da 1/2"

035046
p. 150

PARTI ESTERNE - CROMATO		PARTI ESTERNE - ALTRE FINITURE	
0808/CH/E	€	XX-0808/CH/E	€ x M*
0808/CC/E	€	XX-0808/CC/E	€ 68,00 x M*
PARTE INCASSO			
034034	info pag. 39 €		
PREZZO TOTALE		€	

0808/CH/E | 0808/CC/E + 034036 DX

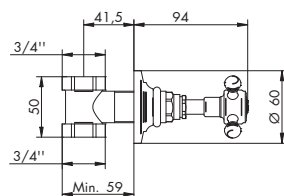

RUBINETTO D'ARRESTO 3/4"

- > vitone ceramico 90°
- > maniglia a croce "HOT" (per art. 0808/CH/E)
- > maniglia a croce "COLD" (per art. 0808/CC/E)
- > ingressi da 3/4"

035046
p. 150

PARTI ESTERNE - CROMATO		PARTI ESTERNE - ALTRE FINITURE	
01-0808/CH/E	€	XX-0808/CH/E	€ x M*
01-0808/CC/E	€	XX-0808/CC/E	€ 68,00 x M*
PARTE INCASSO			
034036	info pag. 39 €		
PREZZO TOTALE		€	

RICAMBI IMMEDIATI



XX = CODICE FINITURA RICHIESTA: per identificare codice corretto vedi pag. 356
M* = MOLTIPLICATORE: per calcolare il prezzo delle altre finiture vedi tabella pag. 356

0840/E + 884053

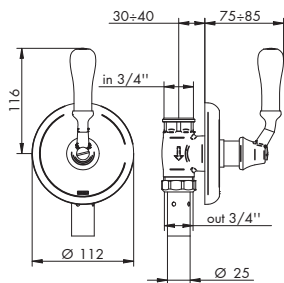

PASSO RAPIDO 3/4"

- > vitone tradizionale
- > abbinare a saracinesca
- > leva con inserto in porcellana
- > ingressi da 3/4"

 884021
p. 151

PARTI ESTERNE - CROMATO

01-0840/E €

PARTE INCASSO

884053 info pag. 42 €

PREZZO TOTALE €

PARTI ESTERNE - ALTRE FINITURE

XX-0840/E € x M*

0840/K/E + 884053

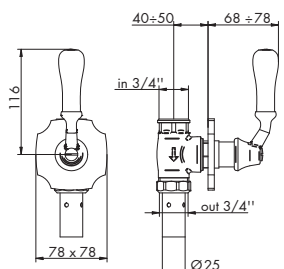

PASSO RAPIDO 3/4"

- > vitone tradizionale
- > abbinare a saracinesca
- > leva con inserto in porcellana
- > piastra classic
- > ingressi da 3/4"

 884021
p. 151

PARTI ESTERNE - CROMATO

01-0840/K/E €

PARTE INCASSO

884053 info pag. 42 €

PREZZO TOTALE €

PARTI ESTERNE - ALTRE FINITURE

XX-0840/K/E € x M*

0840/E + 884054

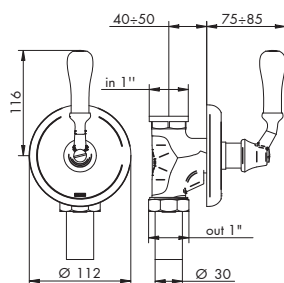

PASSO RAPIDO 1"

- > vitone tradizionale
- > abbinare a saracinesca
- > leva con inserto in porcellana
- > ingressi da 1"

 884021
p. 151

PARTI ESTERNE - CROMATO

01-0840/E €

PARTE INCASSO

884054 info pag. 42 €

PREZZO TOTALE €

PARTI ESTERNE - ALTRE FINITURE

XX-0840/E € x M*

0840/K/E + 884054

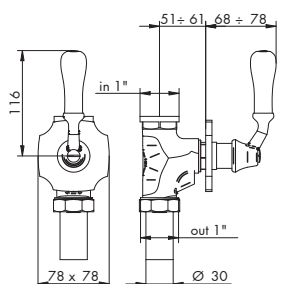

PASSO RAPIDO 1"

- > vitone tradizionale
- > abbinare a saracinesca
- > leva con inserto in porcellana
- > piastra classic
- > ingressi da 1"

 884021
p. 151

PARTI ESTERNE - CROMATO

01-0840/K/E €

PARTE INCASSO

884054 info pag. 42 €

PREZZO TOTALE €

PARTI ESTERNE - ALTRE FINITURE

XX-0840/K/E € x M*

0832/2/E + 035212

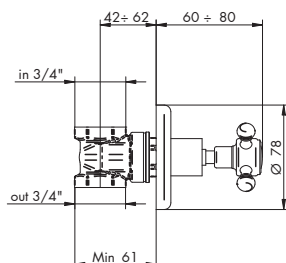

SARACINESCA

- > attacchi da 3/4"
- > maniglia a croce

PARTI ESTERNE - CROMATO

01-0832/2/E €

PARTE INCASSO

035212 info pag. 42 €

PREZZO TOTALE €

PARTI ESTERNE - ALTRE FINITURE

XX-0832/2/E € x M*

0832/2/K/E + 035212

SARACINESCA

- > attacchi da 3/4"
- > piastra classic
- > maniglia a croce

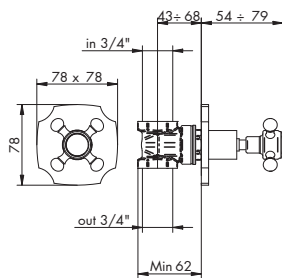
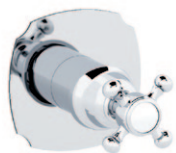

PARTI ESTERNE - CROMATO

01-0832/2/K/E €

PARTE INCASSO

035212 info pag. 42 €

PREZZO TOTALE €

PARTI ESTERNE - ALTRE FINITURE

XX-0832/2/K/E € x M*



EDWARD